

# **N.Z. GEOMECHANICS NEWS**

**No. 54**

**DECEMBER 1997**

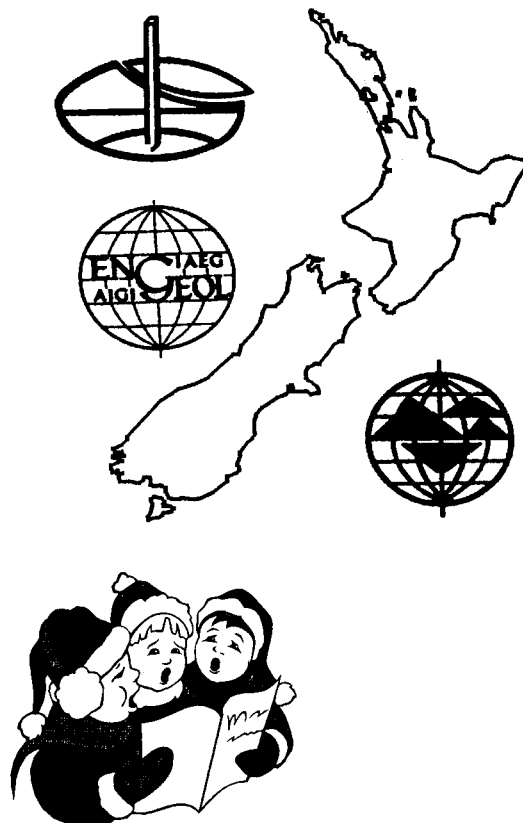

# INNOVATIVE SOLUTIONS

If it's related to retaining, erosion control, drainage, poor subgrades or pavement resealing — we have the solution for you.



**ENKADRAIN**  
walls, basements, roof  
gardens, turf drains

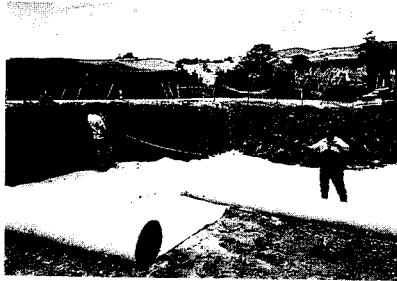

**BIDIM**  
roading & sub-soil fabrics

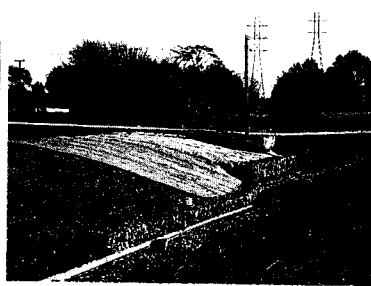

**GABIONS & RENO MATTRESSES**  
**TERRAMAT**  
erosion & re-veg. biomat

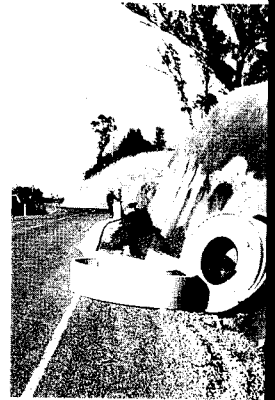

**MEGAFLO**  
roadside, turf,  
subsoil drain



# MACCAFERRI

## NEW ZEALAND

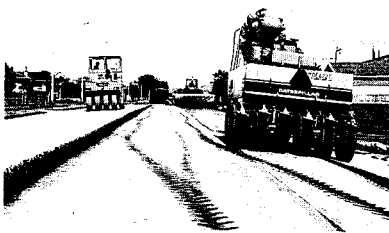

**BIDIM Paving Reseal fabric & HATELIT grids for asphalt and slurry seals**

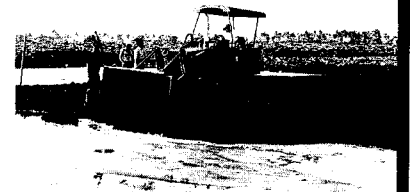

**STABILENKA**  
embankment stability and  
**COLBONDDRAIN**  
vertical wick drains for  
consolidation of soft soils



**ENKAMAT**  
erosion mat for grass, floodways,  
spillways, channels, stopbanks

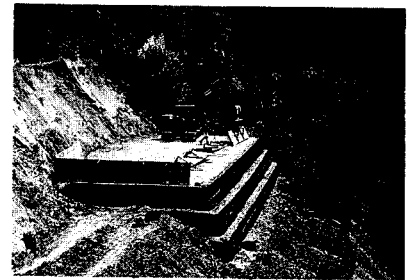

**FORTRAC** geogrid for subgrade/  
sub base and slope  
reinforcement

**Technical manuals, specifications and CAD design assistance available on all products**

**AUCKLAND** — Peter Finlay. Box 12-536, Penrose. Ph 0-9-634 6495. Fax 0-9-634 6492. Mobile 0-25-931 505

**CHRISTCHURCH** — Tony Lingley. Box 6227, Upper Riccarton. Ph 0-3-349 5600. Fax 0-3-349 5796. Mobile 0-25-321 700

Phone or complete the coupon and mail to us today

Please send me information on:

- |   |  |
|---|--|
| <input type="checkbox"/> GABIONS & RENO MATTRESSES                | <input type="checkbox"/> TERRAMAT erosion biomat                       |
| <input type="checkbox"/> TERRAMESH Reinforced gabion walls        | <input type="checkbox"/> ENKAMAT erosion reinforcement mat             |
| <input type="checkbox"/> BIDIM Geofabrics, drains, roads, marinas | <input type="checkbox"/> FORTRAC Geogrids roads/slopes                 |
| <input type="checkbox"/> BIDIM Paving fabrics                     | <input type="checkbox"/> ENKADRAIN Walls, roads, turf, roof gardens    |
| <input type="checkbox"/> BITACK High strength crack bandage       | <input type="checkbox"/> STABILENKA Embankment stability of soft soils |
| <input type="checkbox"/> MEGAFLO Subsoil drain                    | <input type="checkbox"/> COLBONDDRAIN Consolidation drainage           |
| <input type="checkbox"/> SARMAC Protection of submerged pipelines | <input type="checkbox"/> HATELIT Grid for asphalt/slurry seal          |
| <input type="checkbox"/> GEOMAC Soil containment system           | <input type="checkbox"/> BARRIER FENCE Site safety                     |

Name: \_\_\_\_\_  
Position: \_\_\_\_\_  
Company: \_\_\_\_\_  
Address: \_\_\_\_\_  
Phone: \_\_\_\_\_  
Fax: \_\_\_\_\_

# **NZ GEOMECHANICS NEWS**

**NO.54 DECEMBER 1997**

## **A NEWSLETTER OF THE NZ GEOTECHNICAL SOCIETY**

---

### **CONTENTS**

	Page No.
Notes for Contributors	1
EDITORIAL . . . . .	2
NZGS MANAGEMENT REPORTS:	
The Chairman's Corner . . . . .	4
Secretary's Report . . . . .	6
ISSMFE News . . . . .	7
IAEG News . . . . .	11
LOCAL BRANCH ACTIVITIES	
Auckland, Wellington, Canterbury, Otago . . . . .	17
STABILITY GUIDELINES UPDATE . . . . .	20
NZNSEE Pool Members . . . . .	21
LEGAL UPDATE . . . . .	22
TECHNICAL ARTICLE	
<i>Geological Mapping into the 21<sup>st</sup> Century</i> . . . . .	25
M J Isaac, I M Turnbull	
NORTHERN REGION STUDENT PRIZE ABSTRACTS . . . . .	32
• Paul Bassett . . . . .	33
• Meagan Stewart . . . . .	39
• Matthew Brown . . . . .	43
1998 NZGS SYMPOSIUM - NOTICE . . . . .	46
GeoENG 2000 - NOTICE . . . . .	48
1998 IPENZ CONFERENCE - NOTICE . . . . .	49
CONFERENCE DIARY . . . . .	50
PUBLICATIONS OF THE SOCIETY . . . . .	52
NZGS MEMBERSHIP APPLICATION . . . . .	54
ADVERTISING - INFORMATION . . . . .	55

---

*NZ Geomechanics News* is a newsletter for which we seek contributions of any sort for future editions. The following comments are offered to assist contributors:

- Technical contributions can include any of the following:
  - technical papers which may, but need not necessarily be, of a standard which would be required by the international journals and conferences
  - technical notes
  - comments on papers published in *Geomechanics News*
  - descriptions of geotechnical projects of special interest.
- General articles for publication may include:
  - letters to the NZ Geotechnical Society
  - letters to the Editor
  - articles and news of personalities.
  - news of current projects

Submission of text material in camera-ready format is not necessary. However, typed copy is encouraged particularly via e-mail (to the editor) or on floppy disk. Diagrams and tables should be of size and quality for direct reproduction. Photographs should be good contrast black and white gloss prints and of a suitable size for mounting to magazine format. *NZ Geomechanics News* is a magazine for Society members and papers are not necessarily refereed. Authors and other contributors must be responsible for the integrity of their material and for permission to publish.

James Burr

EDITOR

---

#### **THIS IS A REGISTERED PUBLICATION**

*NZ Geomechanics News* is a newsletter issued to members of the NZ Geotechnical Society. It is designed to keep members in touch with recent developments. Authors must be consulted before papers are cited in other publications.

Persons interested in applying for **membership of the Society** are invited to complete the application form at the back of the newsletter. The basic subscription rates are given on the information pages at the rear of this issue. These rates are supplemented according to which of the international societies, (namely Soil Mechanics, Rock Mechanics or Engineering Geology) the member wishes to be affiliated. Members of the Society are required to affiliate to at least one International Society.

**Editor:** J Burr  
PO Box 6345  
AUCKLAND  
  
Phone: (09) 300 9181  
Fax: (09) 300 9300  
E-mail: [jburr@beca.co.nz](mailto:jburr@beca.co.nz)

**Advertising:** A. Murashev  
PO Box 3942  
WELLINGTON  
  
Phone: (04) 473 7551  
Fax: (04) 473 7911  
Email: [amurashev@beca.co.nz](mailto:amurashev@beca.co.nz)

As one of my tasks for the Society during the past year I have been trying to convince members to either attend or sent someone to attend the 3rd Young Geotechnical Professionals Conference in Melbourne in early 1998. I have been rather disappointed by the complete lack of enthusiasm shown by the profession towards participating in this conference. Excuses from senior staff generally revolved around "I sent the flier around the office but no-one stepped forward". I feel that it is the responsibility of senior members of the profession to pick someone who they feel would benefit from this conference and offer them the opportunity to go not just to shove another piece of paper into the circulation list. Preparing and presenting papers at conferences gives an unparalleled opportunity to gain experience in summarising your work, confidence in public speaking and to promote both yourself and your employer as leaders in your field.

The only way the profession will progress is to share knowledge and continuously update our ideas and practices. Attendance at conferences is the best way to find out what everyone else is doing and to judge your own performance. This applies not only to local conferences but also (and possibly more importantly) to international conferences where we can learn from places with much larger budgets than ourselves. For the relatively small cost of one participant we can access millions of dollars worth of information as well as give ourselves an international profile. Anyone who has tried to read through the proceedings of a conference to get a feel for what went on will agree that this is one of the better ways to fall asleep. Someone who was there will have a much better grasp of what the paper was all about and how useful and relevant it really will be to your particular job.

In summary I would urge all members, particularly those with control of budgets, to consider conferences as not just advertising or a junket for a "good" staff member but as an essential part of our ongoing education and the improvement of the profession.

James Burr  
EDITOR

# DRILLWELL EXPLORATION NZ LTD

THE DRILLING SPECIALISTS

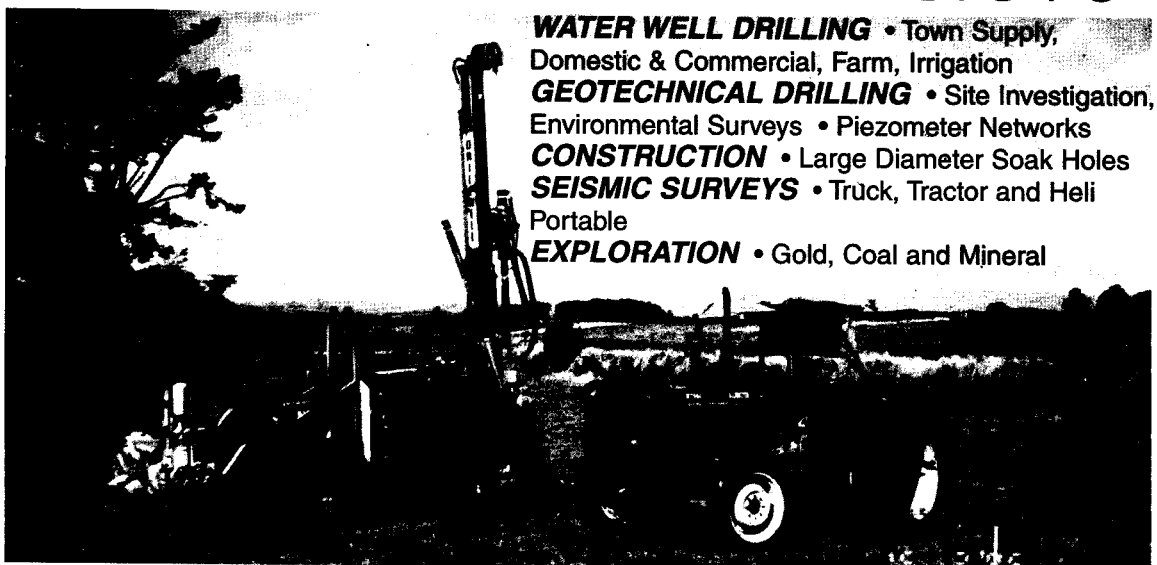

**WATER WELL DRILLING** • Town Supply,  
Domestic & Commercial, Farm, Irrigation  
**GEOTECHNICAL DRILLING** • Site Investigation,  
Environmental Surveys • Piezometer Networks  
**CONSTRUCTION** • Large Diameter Soak Holes  
**SEISMIC SURVEYS** • Truck, Tractor and Heli  
Portable  
**EXPLORATION** • Gold, Coal and Mineral

Ph 0-9-267 9100, Fax 0-9-267 8100

P.O. Box 360 Manurewa, 9 Rawson Way, Takanini, Auckland



# **GRIFFITHS DRILLING (NZ) LTD**

MEMBER OF THE NEW ZEALAND  
DRILLERS FEDERATION

**SPECIALISTS in  
GEOTECHNICAL & ENVIRONMENTAL  
DRILLING  
also  
WATER WELL, SEISMEC, PILING,  
&  
GROUND ANCHORS**

The Company has been operating for many years with the guidance and experience of nearly 50 years, drilling on most NZ dam sites, marine drilling off barges and jack-up platforms, investigation drilling for commercial high-rises, motorways, bridges etc, and in this last decade a substantial amount of Environmental and Methane gas drilling.

With the increasing need for **Static Cone Penetration Testing** GRIFFITHS DRILLING (NZ) LTD is keeping up with the Civil Engineering needs in NEW ZEALAND.

**CONTACT: Melvyn or Gordon Griffiths**  
**Mobile: 021 433 137 or 04 527 7346**  
**PH/FAX 04 526 9943**

**PO Box 40 422 UPPER HUTT**

**WELCOME**

Welcome to the December issue of Geomechanics News for 1997. The year has passed quickly (again!) and the Society has been active with local branch meetings and the organising of the bi-annual symposium next year titled Roading Geotechnics.

It was pleasing to attend the Auckland Student presentations and to see the calibre of work being undertaken. Students from Hamilton and Auckland presented their projects and the presentations were all first class. It was difficult to identify a clear winner for the award of the prize. All the presentations were from students studying engineering geology and I look forward to seeing some engineering students present their work next year.

***Management Committee Re-Structure***

You would have recently received a letter outlining the proposed changes to the management committee structure. Two written responses were received from members, one generally in support and the other questioning the need for a paid secretary and the commitment of members of the Society.

As there was only one member who expressed concern over the move, it was taken that the majority of the membership were generally in favour of the changes. A postal ballot is now being conducted on this issue to formalise the process and to allow the Society Rules to be changed.

***Australian Geomechanics Society***

I attended the AGS Committee Meeting in October and found the trip very worthwhile. The meeting was held in Canberra with the majority of members arriving the night before. A meal at a local restaurant had been organised by IEAust and this allowed members a chance to catch-up with each other and to re-establish contacts.

In general, the Australians are facing many of the same issues and challenges which we are facing. Points of note was the challenges of producing a Society Journal, post graduate training and the development of a web page.

It was suggested that the two Society's Journals could be combined into a single, more frequent magazine along the style of Ground Engineering. I believe there would be benefits to be gained from such a move and this will be explored further. Benefits would include a more frequent journal, wider area of coverage and lower production costs.

Ian Johnston has raised the concept of an extra-mural post graduate qualification for geotechnical professionals. He envisaged the course would comprise a number of specialty papers (typically 10 to 12), each being prepared by a member of a university whom specialised or had strong interest in the topic. A copy of his paper has been circulated to a number of New Zealand academics. I stated that there would be interest in such a course from New Zealand professionals.

AGS is to establish a web page/site. At this stage they are investigating the available options of establishing their own site or using the IEAust site. There appeared to be general consensus for the establishment of their own web site independent of IEAust.

The link with AGS is becoming increasingly important as communication and travel costs decrease. There are a number of advantages to be gained from closer interaction between the two Society's and I will encourage more frequent attendance by representatives at each others management meetings.

I wish all members a Merry Christmas and a Happy New Year and that they have the opportunity to take some leave over the holiday period.

Colin Newton  
NZGS CHAIRMAN

# **Ancor-loc Earth Anchor Systems**

Used extensively, world wide in the Civil and Construction Industries, Ancor-Loc's patented Manta Ray<sup>®</sup>, Duckbill<sup>®</sup> and Screw in Foundations<sup>®</sup> have proved superior against any other system. The logical choice for any anchoring situation, Anchor-Loc Earth anchors provide the assurance of Proof-loading.



## **Benefits**

- *Compression or Tension Application*
- *Suits any ground condition*
- *Loading capacities 2-100 tonne*
- *Proof tested, fast installation*
- *No excavation*
- *Time & cost savings*
- *Environmentally sensitive*
- *Portable lightweight equipment*

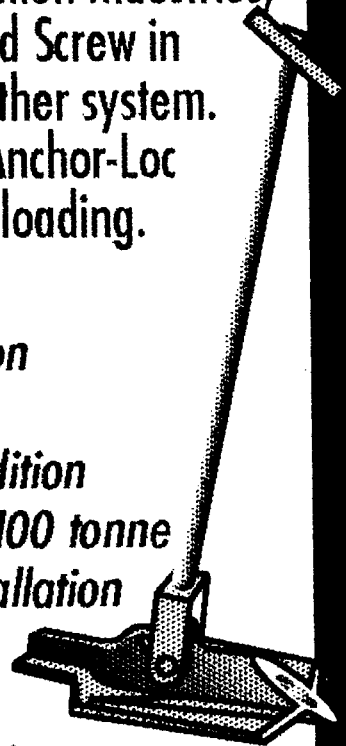

## **Ancor-loc, the obvious solution**

- *Foundation Systems*
- *Micro Piling*
- *Tiebacks*

**Ancor-loc offers a national installation service, temporary foundation hire services and torque probe analysis.**

**ANCOR  
LOC** New Zealand  
Limited

**EARTH ANCHOR SYSTEMS**

**Head Office** PO Box 296, Silverdale Ph: 09 426 5798

Fax: 09 426 0699 Free phone: 0800 224 343

### **Ancor-Loc Certified Installers**

**Auckland** Ph: 09 426 5798 Fax: 09 426 0699

**Waikato/BOP** Ph: 07 872 1749 Fax: 07 872 1746

**Taranaki** Ph/Fax: 06 756 8814

**Canterbury** Ph/Fax: 03 388 8863



**NEW MEMBERS**

New members welcomed into the Society at the last Management Committee meeting are :

M Stewart	S Ramachnadran	M Barakat
R Seyb	D Johnson	N Rogers
M Martin	D Soric	

**1998 AGM**

The 1998 Annual general Meeting of the Society will be held at the Society's Rounding Geotechnics 98 symposium in Auckland next July.

**STABILITY GUIDELINES**

The Society is monitoring the activities of the "Taskforce on Review of Landslip and Hillside Construction Standards" set up after the Threadbo landslide disaster by the Institution of Engineers Australia and the Australian Geomechanics Society. The taskforce is reviewing existing standards and will preparing a standard guideline if it is appropriate. Therefore our Society is holding back development of our own guidelines pending the outcome of the Australian taskforce.

Geoffrey Farquhar  
MANAGEMENT SECRETARY

**PRO - DRILL (AUCK) LTD**

SPECIALIST DRILLING ENGINEERS

**FOR:**

Geotechnical Investigation  
Water disposal drilling  
Ground anchor retention drilling  
Micro Piling  
Water bores up to 50 metres in depth  
Horizontal drilling  
Enviromental drilling  
Piezometer Installation  
Inclinometer Installation

For further information please contact:

Russell Sherwin on 025 -920-760 or Peter Robertson on 025 -937-747

P O Box 119, Tuakau Telephone (09) 309-0471(24 Hours) Fax (09) 236-8836

*Best on Earth*

## **XIVTH INTERNATIONAL CONFERENCE ON SOIL MECHANICS AND FOUNDATION ENGINEERING**

**A K Murashev M.E., Ph.D.  
Beca Carter Hollings & Ferner, Wellington**

The XIVth International Conference on Soil Mechanics and Foundation Engineering was held at the Congress Centre of Hamburg, Germany from 6 to 12 September 1997. The conference was organised by the International Society for Soil Mechanics and Foundation engineering and the German Geotechnical Society. More than 1,500 delegates from 73 different countries attended the conference.

At the opening ceremony the Chairman of the Conference Advisory Board and the Chairman of the German Geotechnical Society, Prof. Whittke made a welcoming address and declared the opening of the conference. The delegates were also welcomed by the Senator of Hamburg, Prof. Hajen and the ISSMFE President Prof. Jamiolkowski.

The Terzaghi Oration - "Geotechnical Aspects of Earthquakes of 1995" was presented by Prof. Ishihara (Japan). Other invited lecturers were Prof. Whittke (Germany), Prof. Krebs-Ovesen (Denmark) and Prof. Tamez (Mexico).

The range of the Conference topics included:

- Soil Testing and Ground Property Characterisation
- Recent Developments in Foundation Techniques
- Retaining Structures and Excavated Slopes
- Underground Works in Urban Environment
- Soil Improvement and Reinforcement
- Waste Disposal and Contaminated Sites

These subjects were presented in six plenary sessions during the Conference and intensely discussed in sixteen discussion sessions. In addition, workshops on 'Education in Geotechnical Engineering' and 'Professional Practice' were held during the Conference.

Scientists, practising geotechnical engineering geologists of the member societies of the ISSMFE presented papers. These papers, together with the theme lectures and discussions are included into the conference proceedings published by A A Balkema Publishers.

The ISSMFE technical committee No.4 organised a special technical session on Earthquake Geotechnical Engineering during the conference. This session provided a forum for researchers and practitioners interested in Earthquake Geotechnical Engineering from all over the world to exchange ideas and to share experiences.

A technical exhibition with at least 50 companies demonstrating their equipment, materials, kits and building procedures took place during the conference.

On 12 September the participants went on a technical visit organised by the German Geotechnical Society to see tunnelling works for the fourth Elb-Tunnel Tube and a site where construction of 50 m deep diaphragm wall was underway.

The ISSMFE Council Meeting was held during the conference. The Council approved the motion put by ISSMFE Board that the name of the society be changed to the International Society for Soil Mechanics and Geotechnical Engineering. The name became effective from 7 September 1997. The Council also elected ISSMGE President for the period 1997-2001. Prof. Kenji Ishihara (Japan), nominated by Indonesia, Japan, Korea, Poland and Sri Lanka was elected ISSMGE President for this period.

The Conference clearly indicated that Geotechnical Engineering has experienced a wide, impressive expansion in the last four years. Next International Conference on Soil Mechanics and Geotechnical Engineering will be held in Istanbul (Turkey) in August 2001.

*The* **SOAKHOLE SPECIALISTS**

**Soakhole, Drainage and Investigation  
Drilling Specialists**



- Free Database Information Service
- Soakage Report After Every Job
- Free On-Site Inspection
- Full Percolation Testing Service
- Site Investigation and Drainage Drilling

Quarry and  
Construction Drilling  
Throughout New Zealand  
Residential, Commercial  
Subdivision and Roothing

**NIEDERER**  
DRILLING

**AK 278-3108**  
**SERVICE - QUALITY - EFFICIENCY**  
Fax: (09) 278 3107 Mob: (025) 782 273

**ABSTRACTS OF ARTICLES PUBLISHED BY  
NEW ZEALAND AUTHORS IN THE PROCEEDINGS OF THE  
XIVTH INTERNATIONAL CONFERENCE ON  
SOIL MECHANICS AND FOUNDATION ENGINEERING**

***Lateral-Spreading Loads on a Piled Bridge Foundation***

**J B Berrill, S A Christensen, R J Keenan & W Okada**

Department of Civil Engineering, University of Canterbury, Christchurch

**J R Pettinga**

Department of Geological Sciences, University of Canterbury, Christchurch

**Abstract:** The effect of lateral spreading on the piled foundations of a multispan highway bridge is studied. It is found that by far the greatest lateral load imposed on the bridge substructure comes from the 1.5 m thick unliquefied crust that is carried towards the river on liquefied sand. The buried piers and raked piles resist its displacement, inducing passive failure in this crustal layer. Trenching at two of the piers on the floodplain of the left bank reveals failure surfaces in the crustal soil consistent with passive failure. Soil strengths were measured by *in situ* direct shear testing and by the CPT. In this case, the passive load on the buried portion of the slab piers is estimated at 850 to 1000 kN per pier, compared with roughly 50 kN in drag forces between the liquefied sand and the set of eight, 400 mm square raked piles per pier. The collapse load of the foundation system is estimated to be about 950 to 1150 kN. Thus the load imposed by the unliquefied crust was very close to the ultimate capacity of foundations designed to the standards of the 1960's. The main conclusion is that in lateral spreading, the chief threat to such piled foundations comes from loads imposed by the unliquefied crust, not from the drag forces of the liquefied soil. In this case, clear evidence was found of passive failure as the crust drove against the buried pier, piled through to firm ground.

***Effect of Age-Strengthening on Initial Stiffnesses and Settlements of Soils***

**A K Murashev**

Beca Carter Hollings & Ferner, Wellington

**Abstract:** Recent experimental and theoretical studies have revealed that the initial stiffnesses of most of the natural sands, residual weathered rocks, and sedimentary clays are in fact higher than those commonly used to predict settlements in routine design. It is believed that the higher stiffnesses develop due to the age-strengthening effect. The laboratory test data obtained demonstrates that the initial stiffnesses of the natural soils depend on the nature and the condition of the bonds between their particles. The factors affecting the initial stress-strain behaviour of natural sands and clays are discussed. Simplified non-linear models incorporating the high initial stiffnesses are suggested and used in numerical modelling of the soil behaviour under shallow circular foundations. The results of computer modelling are compared with field data. It is shown that numerical modelling of the stress-strain behaviour of natural clays and sands on the basis of these models results in more accurate assessments of settlements and the liquefaction potential of soils.

*Solutions Through Polymer Technology*

## HIGH PERFORMANCE GEOSYNTHETICS

- **Syntex™** Nonwoven Geotextiles
- **Syntex™** Woven Slit & Monofilament Geotextiles
- **Landlok™** Turf Reinforcement Mats
- **Landlok™** Open Weave Geotextile for Erosion Control
- **Pyramat™** 3-D Erosion Control Matrix
- **Permaliner™** Containment Lining Membrane
- **NoWeed™** Woven Weedmat

Reinforcement



Soil Stabilisation



Containment Lining



Slope Stabilisation

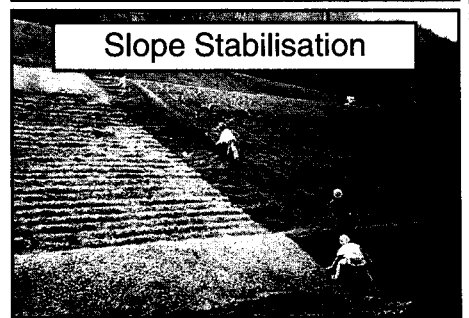

Drainage Systems



Erosion Control

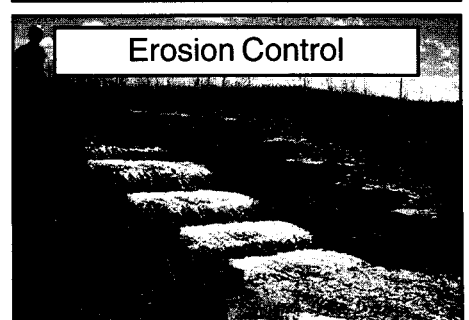

### Permathene Plastics Ltd.

404 Rosebank Rd, Avondale, PO Box 71-015, Auckland 7  
Tel (09) 828 5179 Fax (09) 828 7467 Free Fax 0800 888 333  
<http://www.permathene.co.nz> email: [info@permathene.co.nz](mailto:info@permathene.co.nz)

Manufactured by  
ISO9002  
Certified Company



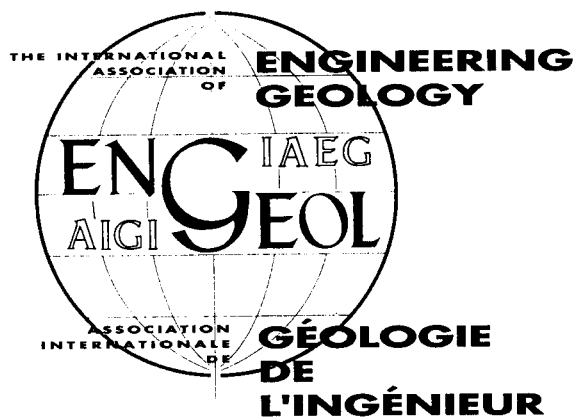

<b>President</b>	: Prof. Paul MARINOS National Technical University of Athens 42, Patission St. 106 82 ATHENS GREECE
<b>Past President</b>	: Prof. R. OLIVEIRA
<b>Honorary President</b>	: Prof. M. ARNOULD
<b>Vice-Presidents</b>	:
Africa	: Dr J.P. VENTER
North America	: Mr J.F. GARTNER
South America	: Mr J.H. SEVILLA
Asia	: Prof. S. WANG
Australasia	: Dr W. M. PREBBLE
Europe	: Prof. A.B. HAWKINS Prof. E. KRAUTER
<b>Secretariat</b>	:
• Secretary general	: Dr L. PRIMEL
• Treasurer	: Dr M. DEVEUGHELE

Vice-President : FOR AUSTRALASIA : WARWICK PREBBLE

**I.A.E.G. NEWS**

Members will be interested to read the following items of news from the I.A.E.G. These are:-

- 1) The Hans Cloos Medal and Wolters Prize winners.
- 2) The main decisions taken by the I.A.E.G. Council at its meeting in Athens, June 22, 1997.
- 3) New arrangements for the publication of the Bulletin.

\* \* \* \*

1) Hans Cloos Medal and Wolters Prize

The voting to award the Hans Cloos Medal and Wolters Prize (which will be presented on the occasion of the next IAEG Congress in Vancouver) took place during the Executive Committee meeting in Athens on June 21, 1997.

The award winners are:

Hans Cloos Medal : Prof. Owen White, Canada

Wolters Prize : Prof. Qin Siqing, China

## MAIN DECISIONS TAKEN BY COUNCIL OF I.A.E.G.

AT ATHENS, JUNE 22, 1997

The IAEG was very pleased and honoured to welcome at its council meeting the Presidents of several International Associations or Societies: R. Brett (IUGS), M. Knight (IAH), S. Sakurai (ISRM), M. Jamiolkowski (ISSMFE), S. Pelizza (ITA) E. De Mulder (IUGS, Commission Co-geoenvironment). The main decisions taken during the Council meeting were:

1. The proposal presented by the Executive Committee aiming at a modification of the name of the Association was thoroughly examined by Council. After voting (40 votes in favour of the modification, 7 votes in favour of the "status quo"), the new name was adopted: "International Association for Engineering Geology and the Environment" \*The acronym with not change (IAEG) and the logo on letterhead and bulletin cover will be slightly modified.
2. The application of three new National Groups was unanimously approved by Council, with applause: Georgia, Lithuania, Mongolia.
3. A limited number of National groups did not pay their fees for several years. In agreement with article IV.C of the statutes, those groups will be advised that their dismissal will be included in the agenda of the next Council meeting in Vancouver, if they have not put their financial situation into order in the meantime.
4. The Executive Committee proposed to Council to change the periodicity of the Bulletin of the IAEG, from 2 per year to 3 or preferably 4. The total number of papers and pages would be slightly increased (around 400 pages per year instead of 340 presently). This change would mean an increase of the work of the Editor in Chief. The decision was taken to appoint two officers (one Editor in chief, one co-Editor, who would particularly deal with the papers written in French) and also to examine whether it would be beneficial for the Association to work with a publisher. The two officers would be distinct from the Secretary General, and would work under the control of the Executive Committee and report to Council every year. Two candidates were proposed by the Executive Committee: B. Hawkins (U.K.) and R. Cojean (France, member of the Council of the French Group). Council unanimously approved this new organization.

---

\* French name: Association Internationale de Géologie de l'Ingénieur et de l'Environnement

5. The change of the periodicity of the bulletin will also lead to an increase of the expenses. Taking this into account and the fact that the fees did not change since 1994, Council unanimously approved (1 abstention) a rise of the fees, which will be 200 French Francs per year (around 32 U.S. \$) for members with bulletin from 1999 onwards. This rise will be applied only to members in high income countries, according to the list of the World Bank. (The fee without Bulletin will be kept at 50 F.F. per year in any case).
6. The Secretary General L. PRIMEL confirmed that he will retire in 1999, which means that he will not renew his candidature next September 1998. The French National Group of the IAEG informed Council that it will present two candidatures for the next Executive Committee: M. Deveughele (present Treasurer) as Secretary General, P. Pothérat (member of the Executive of the French Group) as Treasurer.
7. J. Gartner, IAEG Vice-President for North America presented, on behalf of the Canadian Organizing Committee, a report on the state of progress of the preparation of the 8th IAEG Congress in Vancouver. Second Bulletin should be mailed before the end of 1997. National Groups are asked to dispatch the Bulletins to their members as quickly and as widely as possible.
8. The Council of the South African Institute of Engineering Geologists (South African Group of the IAEG) made a formal bid for the 9th Congress of the IAEG to be held in 2002. The Council warmly thanked the SAIEG for its proposal and agreed to support their endeavours regarding this matter.
9. The creation of a new Commission on "Aggregates" was unanimously accepted by Council. L. Persson (Sweden) will prepare a program which will be submitted to Council in Vancouver.
10. Council unanimously accepted to sponsor the International Conference "GeoEng 2000" (October 23-27, 2000, Melbourne, Australia), jointly with the ISRM and the ISSMFE.

The 1998 IAEG Council will take place on the occasion of the IAEG Congress in Vancouver, most probably on September 20, 1998.

### 3. Proposals for new arrangements for publication of the Bulletin of the I.A.E.G.

At the Council Meeting in Athens, it was agreed that the Bulletin should be issued more frequently and that the printing should be undertaken by an internationally renowned publisher who would take positive steps to promote it. The Council authorised the Executive Committee to negotiate the most appropriate Contract they could with a suitable firm.



We are pleased to inform you that following extensive discussions, we have secured an arrangement with Springer-Verlag which we consider to be very favourable to IAEG and as from 1998, they will be printing and distributing four issues of the Bulletin each year. The numbering of the Bulletins will continue, but the forthcoming March issue will be No 1 of Vol 57, to be followed by Nos 2, 3 and 4 in 1998 before Vol 58 appears in 1999.

This is an exciting opportunity for us to bring IAEG into a more prominent position amongst the geotechnical fraternity and we are confident that Springer-Verlag will make strenuous efforts to promote the Bulletin to non-members and acquire subscriptions from libraries etc. They are also hopeful that it will soon be included on the Citation Index.

Any journal is only as good as the papers it publishes, however, and with four issues per year, we must be careful to ensure the present high standard of papers is maintained. We would also hope that we can attract some of the more well-known names to publish in the Bulletin and we would ask you to take active steps to encourage your colleagues to offer their manuscripts to I.A.E.G. With the increased page numbers per year, it should be possible to publish good refereed manuscripts with the minimum of delay, which we hope will be an added incentive to those with topical issues they wish to disseminate to a wide international readership.

The additional pages will also give us a better opportunity to structure the Bulletin and we are hoping to introduce a series of "themed" papers. Initially we are looking for a number of papers on the engineering geology of well-known cities. If each National Group could provide at least one paper on the engineering geology of a city in their country, this would be the basis of an interesting and truly international series in the first issues of the new Bulletin. I am going to offer a paper on the Auckland urban region.

Full "instructions to authors" will be published shortly.

It is up to all of us to use the Bulletin and to encourage others to submit good papers so that our journal can enjoy the recognition it so richly deserves.

In a recent letter, our President Paul Marinos made the following comments about the new arrangements for the Bulletin:-

- “ We feel this is very favourable to IAEG, the main advantages being:
- a) Springer-Verlag's desire to publicise the Bulletin on the world wide market. They have just agreed a Contract with the IAHR and already publish a number of other journals in allied subjects. These journals are clearly a very attractive marketing package for Springer-Verlag and we can therefore anticipate they will put a considerable effort into advertising and obtaining library subscriptions.

- b) Springer-Verlag have moved extensively into the IT world and would advertise widely using this system. They already have the facility to include not only the table of contents but also the abstracts of the individual papers on the internet. they have subsidiary agencies world-wide and publish a number of good scientific books. We were very impressed by Dr. Engel who is himself a geologist and clearly very active in promoting both his company and its publications.
- c) We all feel the Bulletin is a very valuable contribution to the literature but will not obtain its rightful position in the world until it is more widely available to non-members and hence attracts more well-known authors. Dr Engel explained the requirements for a journal to be included in the Science Citation Index and was confident this could be arranged.
- d) The cost to members will be less than we pay at present. This cost has been guaranteed for 1998, 1999 and 2000.
- e) We have negotiated up to a maximum of 432 pages and four issues in any one year with this low price (DM 32), plus up top four pages per issue with general IAEG information. IAEG itself will now receive 200 copies free of charge for publication purposes.
- f) Springer agreed that we could continue to supply existing subscribers from developing countries ourselves rather than impose a sudden substantial increase in rates.
- g) By inserting a clause (12c) which permits the Association to send out its Newsletter with the Bulletin, we would save a significant postage cost.

Those of us who met Dr Engel in Paris feel that Springer-Verlag are the right publishers for the Bulletin and that we have negotiated a good deal for IAEG.”

I am very encouraged by our President's remarks and I think we can all look forward to supporting a period of considerable development for our Bulletin.

Warwick Prebble  
Vice President, IAEG  
for Australasia

# J M B DRILL SERVICES LTD

P O Box 97566, S.A.M.C.  
Rockdrillers

*Small lightweight, low Headroom -  
Rock Drilling Equipment  
Geotechnical, Construction, Quarry Drilling*

*Free Inspection - Quote*

**All Enquiries:**

*Ph/Fax: Ak (09) 268 1046*

*Ak (09) 278 1665*

*Mobile: (025) 488 248 - (025) 769 675*

**ANYTIME**

## TESTING EQUIPMENT

*Suppliers of testing equipment to the engineering  
and construction industries. Some of our range includes:*

### General Equipment

- Clegg Impact Testers
- Electronic Balances
- Humboldt Nuclear Gauges
- Nomis Seismographs
- pH & Temp Meters
- Conductivity Meters

### Concrete

- Air Meters
- Compression Machines
- Cylinder Moulds

### Aggregate

- Sieve shakers
- Sieves (100mm, 200mm, 300mm & 450mm)

### Soil

- Cone Penetrometers
- Liquid Limit Machines and Grooving Tools
- Scala Penetrometers (inc parts)
- Triaxial Testing Machines, Cells, etc
- Pilcon Shear Vanes
- Geotechnical Instrumentation

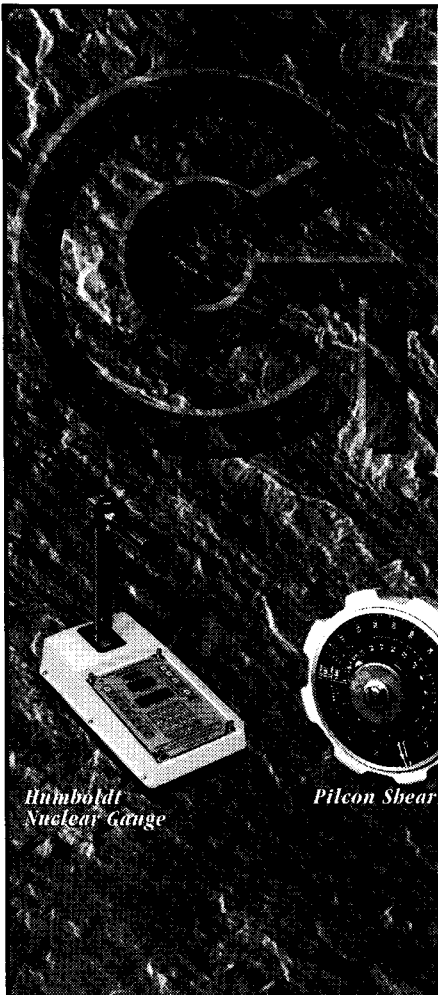

*Humboldt  
Nuclear Gauge*

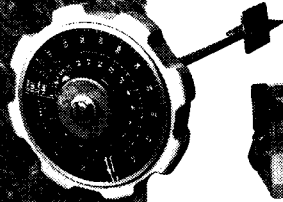

*Pilcon Shear Vane*

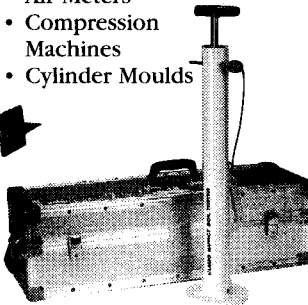

*Clegg  
Impact Soil Tester*

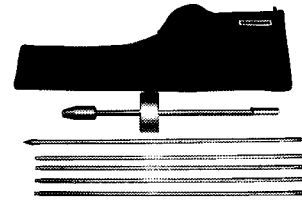

*Scala Penetrometer*

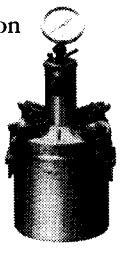

*Concrete Air Meter  
Humboldt*



### GEOTECHNICS LTD - SALES DIVISION

UNIT 3C 76 CARR ROAD MT ROSKILL AUCKLAND NEW ZEALAND

P.O. BOX 27053 MT ROSKILL AUCKLAND NEW ZEALAND

PH: 64-9-620 0280 TOLL FREE: 0508 223 444 FAX: 64-9-620 0281

## AUCKLAND BRANCH

The following technical meetings were held in Auckland since June:

**9 July:** *Melbourne Casino*  
By: Max Ervin of Golder Associates in Melbourne.

Max gave a fascinating presentation about the geotechnical issues involved in constructing the Melbourne Casino on the banks of the Yarra River. The Casino dwarfs ours with a <sup>500,000</sup>M<sup>2</sup> gaming floor with 350 tables. The complex also contains a 40 storey hotel and has a road bridge going through the middle of it. The site is underlain by firm to stiff Coode Island silt with a tongue of basalt intruding. Settlement concerns about the dewatering involved with the 5.7.m deep basement excavation resulted in the use of a "hydraulic wall" to control groundwater drawdown. Problems encountered on site during the construction included poorly cleaned out bases for the bored piles, failures of oversteeped batters and some lateral movement of the bridge pile caps.

**10 September:** *Northern Region Student Prize*

Four students gave presentations on work they had undertaken for their postgraduate degrees. They were:

Paul Bassett:	Influence of Weathering and Hydrothermal Alteration of Engineering Characteristics of Eastern Coromandel Rocks
Matthew Brown:	Engineering Geology of the Kelly Range, Arthur Pass National Park.
Meagan Stewart:	An Engineering Geological Model for Awaroa Opencast Prospect, Huntly.
Iwan Tejakusuma:	Slope Movement and Quaternary Faulting at Beachlands, Auckland.

All four presentations were of high quality and were well appreciated by the audience. At the end of the presentations the judges decided that the winner of the 1997 prize was Paul Bassett.

Thank you to all speakers for their efforts.

James Burr  
AUCKLAND BRANCH CO-ORDINATOR

---

## WELLINGTON BRANCH ACTIVITIES

The Wellington Branch has been relatively quiet over the past six months due to unavailability of speakers. A few technical meetings were held at the IPENZ meeting rooms in Molesworth Street, Wellington. The meeting highlights are summarised below.

**15 April 1997** *Geotechnical Risk Assessment*  
*Mr Bob Semple, Woodward Clyde, Auckland*

Bob talked about risk assessment in geotechnical engineering, and the talk was attended by a number of members in Wellington.

**20 May 1997** *Performance of Reinforced Soil Structures*  
*Mr Mike Dobie, Netlon Limited, Jakarta*

Mike Dobie gave an interesting presentation about the performance of reinforced soil structures around the world, including examples on failures and why they occurred. The performance of reinforced soil walls subject to earthquakes was of much interest to the members who were present in Wellington.

P. Brabhakaran  
WELLINGTON BRANCH CO-ORDINATOR

**CHRISTCHURCH BRANCH**

There have been no activities since the last publication.

Guy Grocott  
CHRISTCHURCH BRANCH CO-ORDINATOR



**OTAGO/SOUTHLAND BRANCH**

Activity of the Otago Branch of the New Zealand Geotechnical Society has been non-existent this year. The annual conference of the Geological Society of New Zealand was held in Dunedin from the 26-28 November 1996 and was a great success. Two engineering geology sessions were held and thanks to all who prepared presentations.

It is hoped that we can get Nick Eldred of Woodward Clyde to Dunedin to talk about the Geology and groundwater conditions of the second Manapouri Tailrace Tunnel in December 1997

I would like take this opportunity to remind all members that I am open to ideas about any meeting or events they have in mind and that some assistance with organising these events would be more than appreciated. The local IPENZ branch has offered to assist with bringing a key speaker to Dunedin and this might enable us to get next year's Geotechnical lecture to Dunedin. Other activities for next year might include a seminar on the McArthurs Bend realignment of State Highway One by Ian Walsh of Opus and possibly a local workshop on the new roading materials standards and their application.

Phil Glassey  
OTAGO/SOUTHLAND BRANCH COORDINATOR

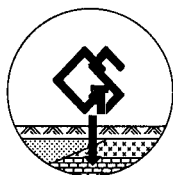
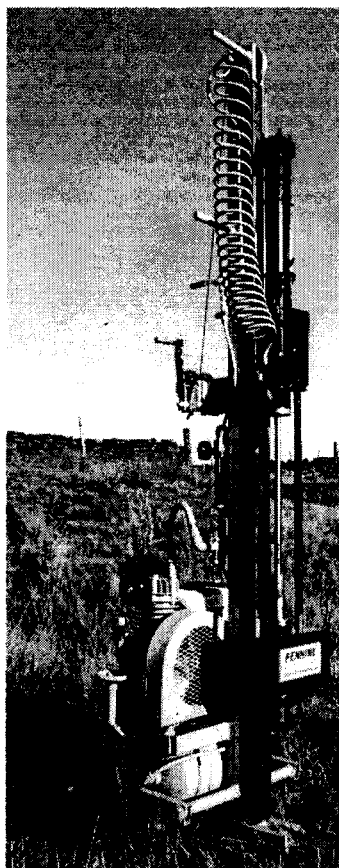

**GEOTEK SERVICES LIMITED**

3 Sale Street, Howick, Auckland, New Zealand  
 P.O. Box 39-015, Howick, Auckland, 1705  
 Phone (64-9) 535-9814  
 Facsimile (64-9) 535-7243

E-mail geotek@netgate.co.nz

Proudly present:

**THE PENNINE DYNAMIC PROBE & SAMPLER**

A rapid cost effective method for the assessment and sampling of ground conditions, including the installation of standpipes and monitoring tubes.

For further information on:  
**SALES, HIRE & OPERATION**  
 Telephone: (09) 535 9814  
 Mobile: (025) 735 712  
 Facsimile: (09) 535 7243

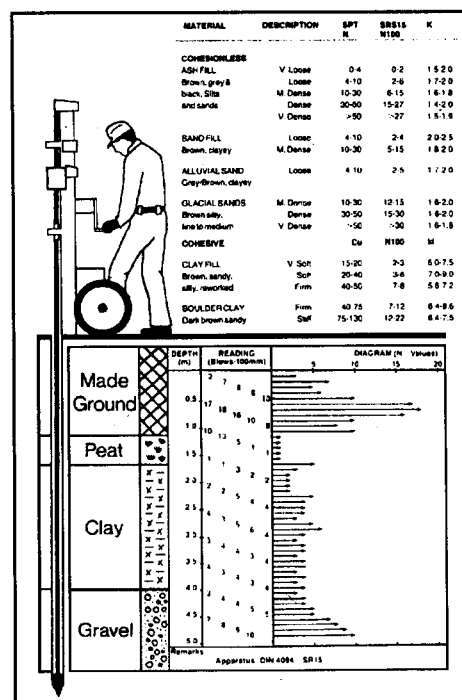

# GEOTECH DRILLING

*A fully mobile, self contained,  
auger & penetrometer rig,*

*specialising in:*

**Auger & Penetrometer Work.**

**Site Investigation.**

**Environmental Drilling.**

---

**Mobile: 025 949726**

**Ph/Fax: 07 3782016**

**TAUPO, NZ**

## **Review of Landslides and Hillside Construction Standards**

Following the Thredbo landslide earlier this year, IEAust and AGS have established a Task force made up of members of AGS, IEAust and other representatives from those responsible for highways, railways and Local Government. The Terms of Reference (ToR) were:

- To review the adequacy of Australian Standards and Relevant Codes on Landslides and Hillside Construction.
- To recommend improvements to Australian Standards and Relevant Codes on Landslides and Hillside Construction.
- If appropriate, to develop an Australian Standard Guideline document or similar.

The Taskforce is chaired by Prof Robin Fell and includes twelve members with seven corresponding members including two NZGS members and Dr Chris Graham representing Transit NZ.

The Taskforce held its first meeting in October to cover the first two ToR items and prepared a report. The ToR was discussed and a number of points agreed. The first two ToR items were discussed and a large number of concluding points were established. The main points raised was the need to develop guidelines on where hazard zoning is needed, how it should be carried out and how to brief a consultant to undertake the task. Registration of geotechnical professionals was also considered and some guidance on this issue is being sought.

It was recommended that guidelines be developed for:

- hazard zoning
- slope management
- site investigation, design construction and maintenance of slopes, and
- landslide risk assessment.

Prior to proceeding further, the Taskforce is awaiting a response from its sponsors, AGS and IEAust.

Colin Newton  
NZGS CHAIRMAN



**POOL MEMBERS REQUIRED**

Are you interested in earthquakes? Experienced geotechnical engineers and engineering geologists are required to join the pool of people available for reconnaissance missions. The pool in the Auckland region is particularly small. In past years the Geotechnical Society has joined with NZNSEE to encourage geotechnical professionals to join the pool.

The aim is to investigate damaging earthquakes that occur in NZ and where important lessons can be learned, those that occur overseas. The investigation usually takes the form of a reconnaissance or field inspection of the damaged area to record information that otherwise might be lost due to demolition, repairs or weathering. Participants are not paid but expenses are covered. Participants must prepare a report and present it to the profession in NZ. NZNSEE reconnaissance missions are highly regarded in the international earthquake engineering community for the reconnaissance reports published.

Interested persons should contact :

Michael Brice  
Administrative Secretary  
NZ National Society for Earthquake Engineering  
32A Horopito Road  
PO Box 312  
WAIKANAE

Phone/Fax 0-4-293 3059

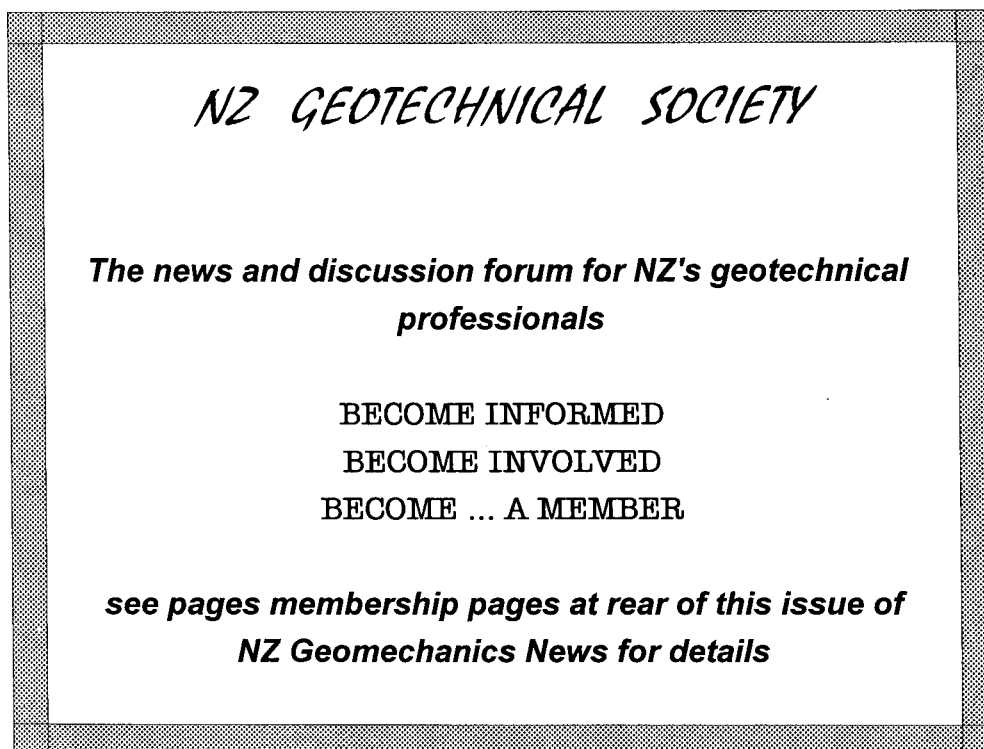

***NZ GEOTECHNICAL SOCIETY***

***The news and discussion forum for NZ's geotechnical professionals***

BECOME INFORMED  
BECOME INVOLVED  
BECOME ... A MEMBER

***see pages membership pages at rear of this issue of  
NZ Geomechanics News for details***



## **LEGAL UPDATE**

### **Smail V. Buller DCP**

#### ***Cliff Instability***

This was a claim for diminution of property value resulting from the council's negligence or breach of statutory duties in authorising resort development and issuing building permits at Little Wanganui. The diminution in value resulted from cliff instability, which posed a risk to both life and property, particularly in the event of earthquake. The plaintiffs were representatives of 54 property owners. It was recognised that each case would be different, and leave was reserved for other plaintiffs to give further evidence.

#### ***Subdivision; change of Use***

A change of use for the area from rural to "resort zone" was approved in 1973. The first and second stages of the subdivision were approved, subject to conditions, in 1973 and 1975. The first plaintiff's building permit was granted in 1978.

#### ***Awareness of the Risk***

Concern about the cliff stability was first documented by the council in 1981. A DSIR geological report for the purposes of a proposed district scheme was obtained in 1983. This made no mention of instability in the area, but did refer to the danger of rock falls at Punakaiki. At the council's request the DSIR delineated a "hazard zone" which included Punakaiki but made no mention of Little Wanganui.

The Court accepted evidence that in February 1984 a DSIR engineer visited the site, with a council engineer, and expressed the opinion that he believed "that the whole subdivision could be threatened by potential rock fall". A full report on the area was commissioned in 1990, in response to a building inspector's concerns. Following this, the council notified the possibility of a public indemnity liability claim to the NZ Local Government Insurance Council (NSLGIC). Further reports recommended building restrictions.

Following rockfalls in December 1991, the council tried to persuade residents to leave, changed the hazard line in the district plan, and resolved to issue building consents only with conditions that an entry be made on the certificate of title evidencing the relevant hazard and protecting the council from civil liability in the event of damage.

#### ***Judicial Immunity***

In considering whether a defence of judicial immunity was available, the Court considered whether the statutory process of making the decision was of a judicial character.

The council's decision to approve a change of use was made under the TCPA53 and involved public notification, hearings, and questioning of witnesses. The Court considered this was in the nature of a judicial decision, and should be protected by judicial immunity. However, the council's decision to approve the subdivision scheme was made under the Counties Amendment Act 1961. This was a purely administrative decision, and so was not subject to judicial immunity.

#### ***Negligence***

Despite the finding that the council's land use change decision was judicially immune, the Court considered whether the council was negligent in failing to adequately investigate the cliff stability when making that decision. The Court found that it was unrealistic to expect the council to have recognised the threat in 1973. Causes of action based on the 1973 change of use and 1975 subdivision consent decisions therefore failed.

The Court found the council was on notice of the risk from February 1984 and was negligent for not adopting an adequate response.

#### ***Building Permits***

Causes of action based on building permits issued before 22/12/83 were time barred. The Court held that, under the LGA74 and amendments, the Council was bound to refuse to grant permits when damage was likely to arise directly or indirectly from erosion, subsidence, or slippage, not only on the building land, but also from erosion, subsidence, or slippage of any other land. Breach of this duty conferred on the affected permit holder a right to seek damages. The Court held damages for economic loss were recoverable where breach of statutory duty was established.

The Court held councils could be held liable for negligence in granting building permits where risks to life and property arose from failure of an external, but nearby, landform.

#### ***Ministry of Works***

The Court concluded that on the evidence there was no ground for fining that in 1973, when considering the proposals, the Ministry was in breach of its statutory duty or any common law duty of care in not recommending that the proposals be rejected because of the cliff instability.



# GEOTECHNICS LTD ROAD TESTING UNIT

*Geotechnics offers a comprehensive road testing service which incorporates a wide range of testing applications from single lane unsealed rural accessways to multi-lane highways and motorways. The Road Testing Unit is purpose built for a range of TELARC registered services including:*

## DEFLECTION TESTING (BENKLEMAN BEAM)

This service utilises a standard Benkleman Beam where pavement deflections are measured and recorded with preliminary results issued on site, followed up by a formal test report.

## DEFLECTION TESTING (GEOBEAM)

Using our patented Geobeam, deflection measurements are made via an electromagnetic proximity transducer located at the point of test. This system provides for both standard deflection information and detailed bowl shape at every test point if required. The information is automatically recorded and stored on a hand held site computer and can be used to determine subgrade moduli and analysis of pavement component performance.

This service has particular application on existing pavements where subsurface information is required for design purposes.

Standard test loads of 7.3 tonnes and 8.2 tonnes are available for deflection testing.

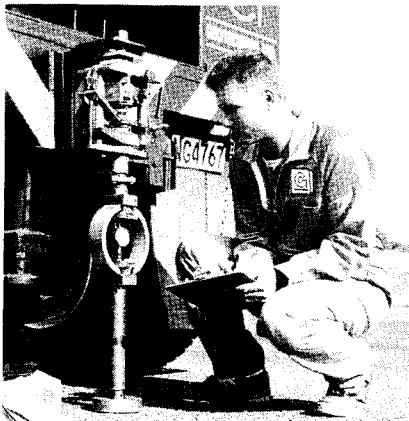
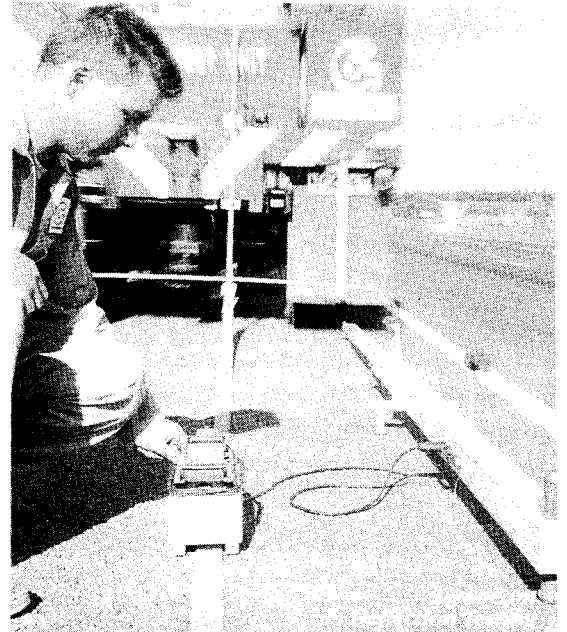

## FIELD CBR AND PLATE BEARING TESTING

The unit has also been designed to perform Californian Bearing Ratio and Plate Bearing Tests and has built in facilities and equipment for the performance of these tests.

## FULL TIME TEAM

The Road Testing Unit is operated by a two man team who are committed full time to its operation and maintenance. We aim to provide a timely, cost competitive service which meets the demands of the civil engineering and construction industries.

## THE FALLING WEIGHT DEFLECTOMETER

Using the Falling Weight Deflectometer (FWD) Systems and associated analysis software, it is possible to quickly and accurately determine the structural condition of the pavement system. The required overlay or other rehabilitation alternatives are calculated from analytically based structural design methods, at a cost which is negligible compared to the cost of an incorrect rehabilitation strategy.

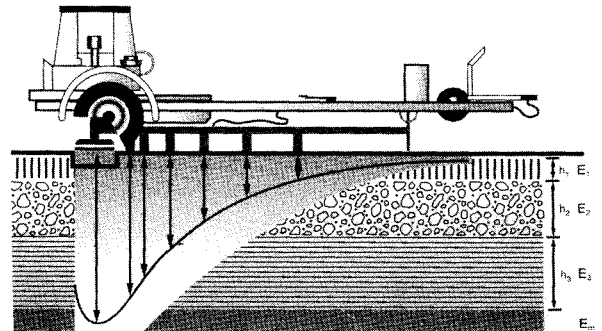

**GEOTECHNICS LTD**

19 MORGAN ST. NEWMARKET, AUCKLAND.

TELEPHONE (09) 3793067 FAX (09) 3070265 MOBILE (025) 747693

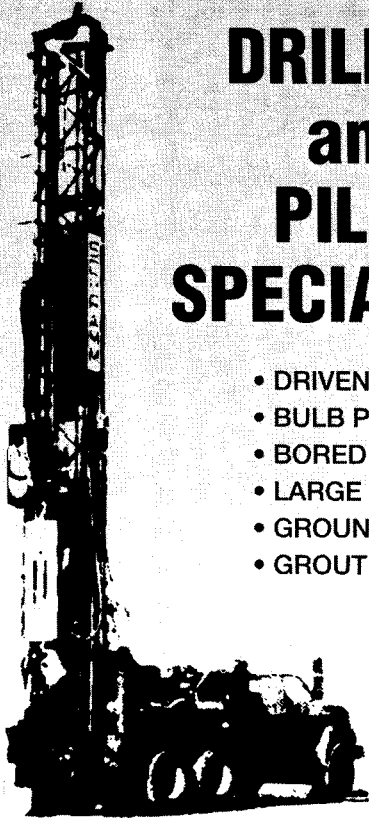

# DRILLING and PILING SPECIALISTS



- DRIVEN PILES
- BULB PILES
- BORED PILES
- LARGE DIA CAISSIONS
- GROUND ANCHORS
- GROUTING

- WATER BORES
- WATER WELLS
- TEST DRILLING
- GEOTECHNICAL INVESTIGATION
- ENVIRONMENTAL DRILLING
- MINERAL EXPLORATION
- WIRELINE CORING
- RC DRILLING
- CABLE TOOL DRILLING
- AIR CORE DRILLING

**INSTALLATION OF:**

- PIEZOMETERS
- INCLINOMETERS
- WESTBAY PIEZOMETERS

## McNEILL PUMPING AND IRRIGATION

(A DIVISION OF McNEILL DRILLING CO. LTD) Head Office: Boundary Road, P.O. Box 95, Alexandra.

**AUTHORISED DISTRIBUTOR FOR GRUNDFOS LEGENDARY PUMPS**

**PUMPING, WATER SUPPLY AND IRRIGATION SPECIALISTS SUPPLIERS OF PUMPS AND SPARES FOR:**

GRUNDFOS  
DAVIES ONGA  
WILDEN  
JABSCO  
INDENG  
GORMAN PUMP

RENOWN  
ROPER  
OBERDORFER  
HIDROSTAL  
YARDMASTER  
SOUTHERN CROSS

MONO  
FYNSPRAY  
AJAX  
JOHNSON  
TSURUMI

ROBYNS & MEYERS  
PACIFIC  
UNITED  
STANDARD  
NZ SEAL SERVICES

SEEPEX  
PEERLESS  
JESCO  
FLOJET  
NOCCHI

**SUPPLIERS OF PUMPING AND IRRIGATION ACCESSORIES:**

POLY PIPE & FITTING  
PRESSURE TANKS  
VALVES

PVC PIPE & FITTINGS  
HOSE & FITTINGS  
PACKING

GALV. PIPE & FITTINGS  
SPRINKLERS  
BACK FLOW PREVENTORS

**SYSTEM DESIGN, SUPPLY INSTALLATION AND SERVICING FOR:**

WATER TREATMENT  
TURF IRRIGATION  
DOMESTIC SUPPLY

SWIMMING POOL EQUIPMENT  
TRAVELLING IRRIGATORS  
INDUSTRIAL PUMPING

FROST PROTECTION  
STOCKWATER RETICULATION  
RURAL WATER SCHEMES

**BRANCHES AT:**

ALEXANDRA  
BOUNDARY ROAD  
PHONE 0-3-448 7049  
FAX 0-3-448 9420

CHRISTCHURCH  
151 WATERLOO RD, HORNBY  
PHONE 0-3-349 4443  
FAX 0-3-349 4449

DUNEDIN  
DONALD STREET  
PHONE 0-3-488 4227  
FAX 0-3-488 3042

INVERCARGILL  
OTEPUNI AVENUE  
PHONE 03-216 6035  
FAX 0-3-216 6010

---

**Geological Mapping into the 21st Century****QMAP and GIS****M.J. Isaac<sup>1</sup> and I.M. Turnbull<sup>2</sup>**<sup>1</sup> Institute of Geological & Nuclear Sciences, PO Box 30368, Lower Hutt<sup>2</sup> Institute of Geological & Nuclear Sciences, Private Bag 1930, Dunedin

**ABSTRACT:** QMAP is a geological mapping programme which will build a digital geological database of the whole country and publish maps and books to document it. The programme is funded by the government from the Public Good Science Fund. QMAP research involves assessment of previous work, field and laboratory investigations in key areas, and data storage, manipulation and publication using Geographic Information Systems (GIS) computer technology. The QMAP digital database of New Zealand geology will be completed by 2006, as will the series of 21 full colour printed geological maps and accompanying explanatory texts. Two are already completed and published (Kaitaia and Dunedin), and six other projects are well advanced.

QMAP information will also be available in digital form, and we hope to expand the scope to include the linking of many other earth science databases to QMAP. The intention is to develop internet access to the databases, to make the information publicly available. The relevance and the fundamental value of QMAP lie in the greatly improved geological knowledge it will provide for end-users of geological information.

**1 INTRODUCTION**

Geological mapping is the most effective method of interpreting and presenting knowledge of regional geology so that it can be used, for example, in resource assessment, in hazard evaluation, and in land-use planning (Bernknopf and others 1997). The QMAP programme started in 1994, in response to a recommendation by the Ministry of Research, Science & Technology Review of Science in New Zealand, Geology & Energy Research (1993):

“Revised geological mapping at a scale of 1:250 000 is urgently required. Additional resources need to be applied to the regional mapping programme, in particular employing energetic field mappers.”

New mapping and the better organisation and presentation of existing unpublished mapping are urgently required because of the inadequate and dated nature of many of the published New Zealand geological maps. The previous national coverage was completed between 1959 and 1968, before the plate tectonics concept revolutionised the science of geology. Though some maps have stood well the test of time (e.g. Auckland, Oamaru), others (North Cape,

Whangarei, East Cape) are no longer acceptable. Some of the older maps were known to be based on educated guesses even at the time they were produced. The Fiordland map was completed before there were topographic maps for part of the area, so in places the base map used was Captain Cook's chart.

Recent advances in Geographic Information Systems technology (GIS) have revolutionised methods of dealing with geological data, so that a geological map is no longer represented by a single sheet of paper. The map is now just one product from a complex database which can be queried and used in many ways, for example, in three-dimensional modelling and interpretive data analysis. QMAP (the Quarter Million Mapping Programme, 1:250 000 scale) will complete a modern 1:250 000 geological map and digital database for all New Zealand, built from 1:50 000 compilations, using GIS software. Reasons for placing high priority on such work include:

- recognition that the geology is poorly known for large parts of the country
- the potential for discoveries
- the vast amount of new information in mining reports, theses, and papers
- a widespread need (proven by client demand) for



Institute of  
**GEOLOGICAL  
& NUCLEAR  
SCIENCES**  
Limited

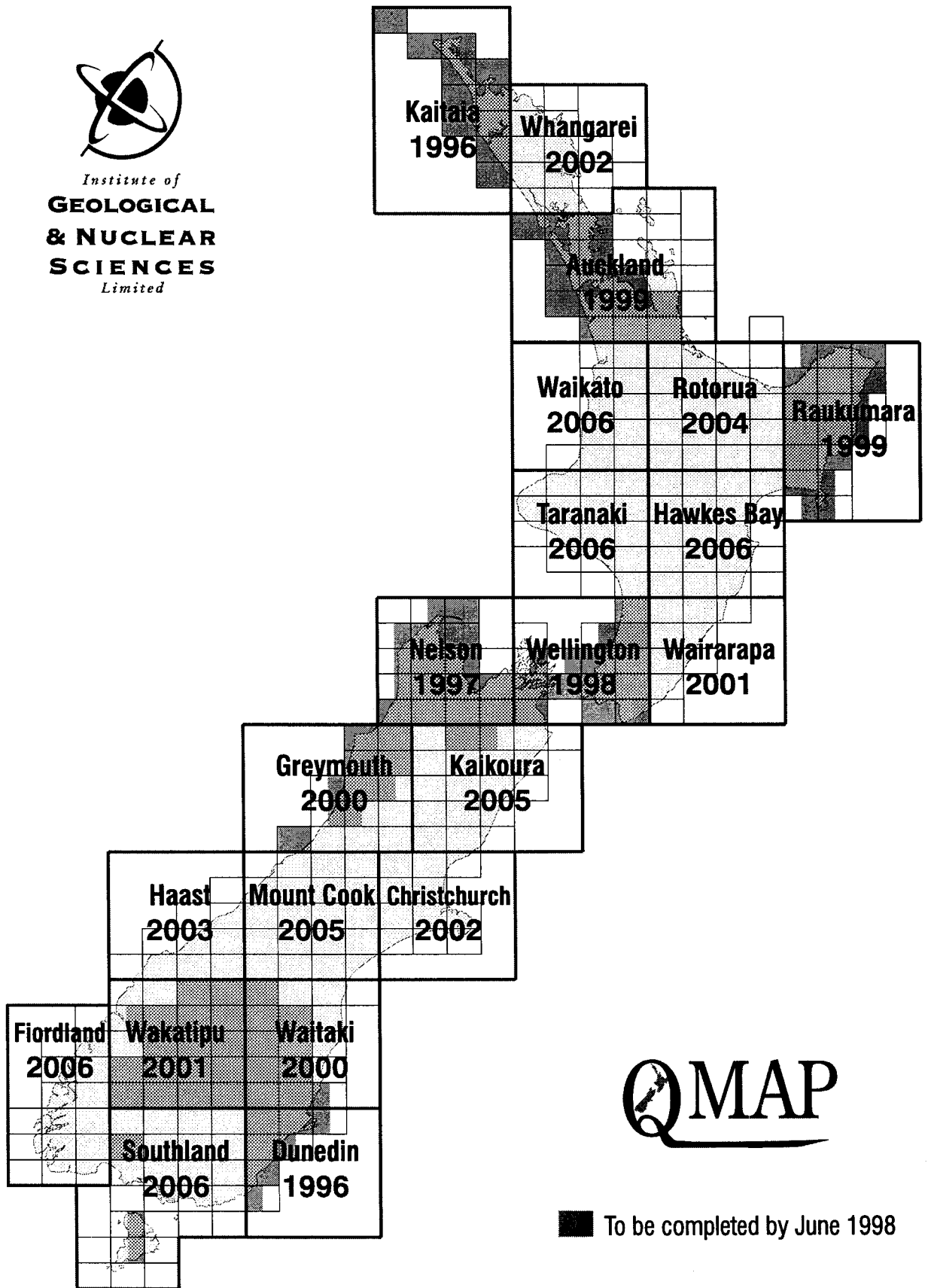

Figure 1. QMAP project areas, map sheet names and completion dates.

good geological data for

- regional and district councils
  - mining and oil companies, and
  - other Public Good Science Fund (PGSF) programmes
- the need to modernise data acquisition and output by using computers
- the possibility of providing on-line access to database holdings.

The move to GIS technology is essential for any modern system of information transfer, though paper maps are still necessary as only a proportion of users have access to expensive GIS software and hardware. Paper maps are seldom reprinted, but a digital database is easy to update, and can thus always provide the best available information even if only in the form of computer printouts. GIS technology has also cut the cost of draughting and printing the conventional maps.

## 2. PROGRAMME DESIGN

For QMAP, New Zealand has been divided into 21 project areas (Figure 1); a series of geology "layers" are compiled in the GIS digital database for each area (Figure 2), and these are used to produce the final 1:250 000 scale map. Each published map is accompanied by an explanatory map text in book form. The digital database compiled during each project is edge-matched with those from neighbouring projects, to ensure the end-product will be a seamless map of New Zealand geology. A description of the data standards and types of information stored in the digital database is published elsewhere (Rattenbury & Heron 1997).

Mapping is based on the Land Information New Zealand 1:50 000 national topographic coverage. Previous work is assessed for each 1:50 000 sheet, and the boundaries of areas already mapped are recorded on a data source sheet and digitised. Fill-in field work and new research are focussed on areas of inadequate knowledge, and on areas where significant advances are possible for the resources available. The amount of staff time spent on new field research will vary according to need, and for some areas (e.g. Auckland, Christchurch) the major scientific advances may come from integration and synthesis of existing data. For other projects (Kaikoura, Wakatipu, Fiordland), field campaigns will be mounted for several consecutive summers.

Field sheet data is transferred in neat form to a record sheet compiled on stable film. Smoothing and culling of data for representation at 1:250 000 results in the compilation sheet, which is digitised to provide the linework for the published map. "Point" data (e.g. structural information, fossil localities, mineral occurrences) and attribute data for linear features (e.g. whether or not a fault is active) are entered into the database using EXCEL spreadsheets (Figure 3). An explanatory text of less than 30 000 words pitched at "informed lay person" level is written for each map, and illustrated with colour photographs and diagrams. Maps and texts are published because relatively few users can access digital data, because sales prove the demand, and for use in the field. They will be the de facto "Geology of New Zealand" for many years to come.

## 3 KEY RESULTS

- GIS design is complete, and it is being used to produce maps for publication.
- The QMAP GIS capability is also being used in many commercial projects.
- The Dunedin 1:250 000 map was completed in 1996 (Bishop & Turnbull 1996).
- The second map and book (Kaitaia) are also published (Isaac 1996).
- The Nelson database and map are completed (Rattenbury and others in press).
- Auckland, Raukumara, Wellington, Wakatipu and Waitaki will be 75% compiled by the end of current funding (30 June 1998).

More detailed maps can be produced on request from the QMAP 1:50 000 compilation sheets, and plotted in-house on an HP755C colour plotter. Associated analytical and derivative work has progressed to the stage where one-off single-factor and multiple-factor maps are produced on request from the GIS database for commercial clients. To date the major advances have been in modelling maximum credible earthquake magnitudes and in assessment of ground shaking hazards. Data analysis has also been used to predict gold prospectivity, and to estimate petroleum reservoir characteristics.

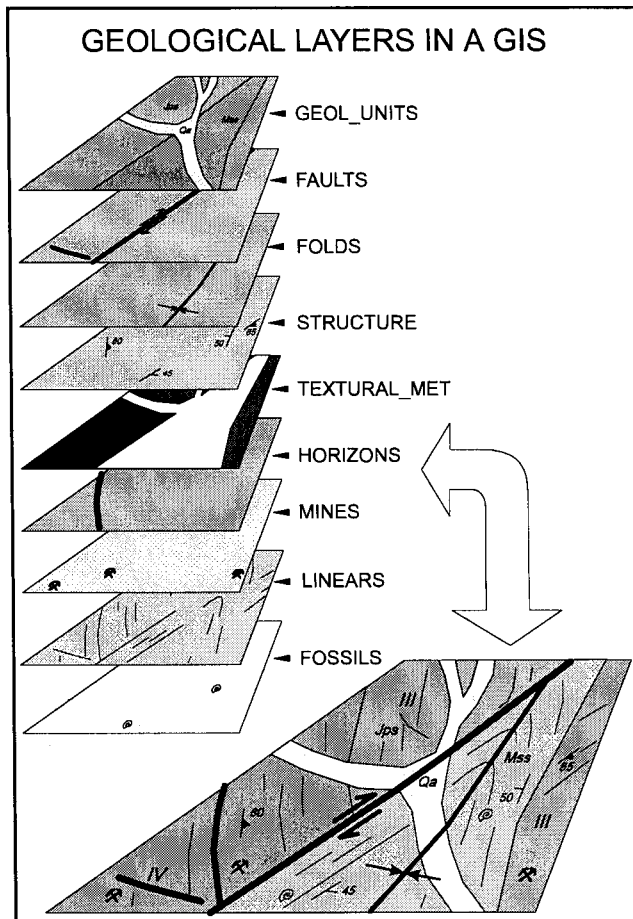

**Figure 2.** Geological layers in the QMAP Geographic Information System.

#### 4. FUTURE DIRECTIONS

QMAP was conceived as a long term programme, and by June 1998 will be 40% complete. The aims are being achieved, and the methods and database work will be refined, but not radically changed. Next field season we intend to trial the direct digital capture of field data using palm-top computers, as developed and used by the Australian Geological Survey Organisation. "GIS in the field" using laptop PCs is also under development in conjunction with other PGSF programmes.

This year we started to expand the scope of the programme, to link other digital databases (Active Faults, Landslides, and Geochronology) to the QMAP geology coverage, and we hope to do more in the future. QMAP could provide the geological component to add value to many other specialist earth science databases, some of which already contain data in partly compatible format (i.e. spreadsheet based, with x-y co-ordinate information). Using the GIS capability to combine QMAP geology and, for

example, landslides mapping will make it possible to identify which geological units are landslide-prone. The combined geology and landslides coverages could, for example, be linked to analyses of slope angle and slope aspect, and used as a predictive tool for hazard assessment.

Government policy is that the results of publicly funded science should be "made available by providers to the public and stakeholder groups through appropriate means at the marginal cost of dissemination" (Minister of Research, Science & Technology 1997). That suggests the QMAP data should be available for little more than the cost of retrieval. The outcome we aim for is the provision of direct access through the internet to the earth science databases which have been built with government-provided Public Good Science Fund money. Development of that capability is, however, dependent on us getting sufficient funding.

#### 5. RELEVANCE TO CIVIL ENGINEERS AND PLANNERS

Though specific site investigations obviously require more detailed work than that done for QMAP, the QMAP revision of New Zealand geology will at least allow more

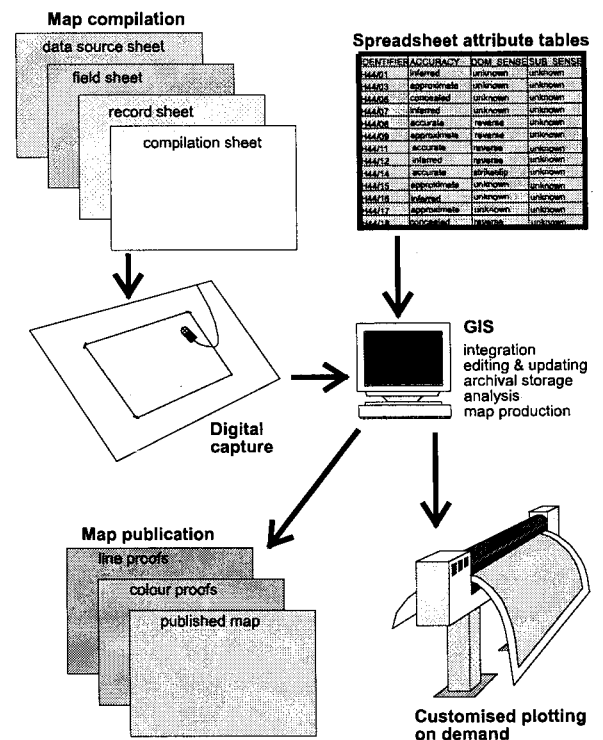

**Figure 3.** QMAP data compilation, data capture and map production techniques.

detailed work to be put into a modern geological context. Detailed 1:50 000 geological maps have recently been published for parts of New Zealand (including, for example, the major urban areas of Auckland, Wellington, Christchurch and Dunedin), and these show more information than the 1:50 000 compilations prepared for QMAP. However, for much of the country QMAP 1:50 000 compilations will for many years be the best available geological maps, simply because the available resources are insufficient for more detailed work. Colour plots of QMAP 1:50 000 compilations can be ordered from the Institute, and in future we hope they will be available over the internet. Maps can be ordered for any geographic area (provided that the area has been covered), and they can be plotted at any scale. We use ArcInfo, but can if required supply digital data in formats suitable for other GIS packages.

The published 1:250 000 QMAP sheets show geological units, major landslides, major active and inactive faults, and the location of the major roads, railways, population centres, rivers and streams. Map texts give a summary of the geology, the natural hazards, and the resources. Each text also includes a data source diagram, to help users locate information at smaller scales. The value of the QMAP digital database will be greatly enhanced when we can easily link QMAP geology coverages to datasets such as the Large Landslides Inventory and the Active Faults Database. We hope to develop that capability in the next year. Both the GIS capability developed for QMAP and QMAP data have in the last two years been used for many detailed geological mapping and hazard modelling projects undertaken for commercial clients. We have found that work to be very rewarding (both scientifically and financially!), and therefore welcome enquiries.

## REFERENCES

- Bernknopf, R.L., Brookshire, D.S., McKee, M. 1997. Estimating the social value of geologic map information: a regulatory application. *Journal of environmental economics and management* 32: 204-218.
- Bishop, D.G., Turnbull, I.M. 1996. Geology of the Dunedin area. Institute of Geological & Nuclear Sciences 1:250 000 geological map 21. Institute of Geological & Nuclear Sciences, Lower Hutt.
- Isaac, M.J. 1996. Geology of the Kaitia area. Institute of Geological & Nuclear Sciences 1:250 000 geological map 1. Institute of Geological & Nuclear Sciences, Lower Hutt.
- Minister of Research, Science & Technology 1997. The Government's Policies and Priorities for Public Good Science and Technology. Notice to the Foundation for Research, Science & Technology. Wellington, New Zealand. Ministry of Research, Science & Technology.
- Ministry of Research, Science & Technology 1993. A Review of Science in New Zealand - Geology & Energy Research. Ministry of Research, Science & Technology science review 7.
- Rattenbury, M.S., Cooper, R.A., Johnston, M.R. in press. Geology of the Nelson area. Institute of Geological & Nuclear Sciences 1:250 000 geological map 9. Institute of Geological & Nuclear Sciences, Lower Hutt.
- Rattenbury, M.S., Heron, D.W. 1997. Revised procedures and specifications for the QMAP GIS. *Institute of Geological & Nuclear Sciences science report 97/3*.



**Do you know what's there before you dig ?**  
**Do you want to save money ?**

With the best intentions in the world and the records available there is still a **high risk in all subsurface work.**

The use of **Ground Radar** removes most of **these unknowns** and is a *cost effective* tool for eliminating disruptions and improving economics on the job. It allows you to know what you are dealing with before you start.

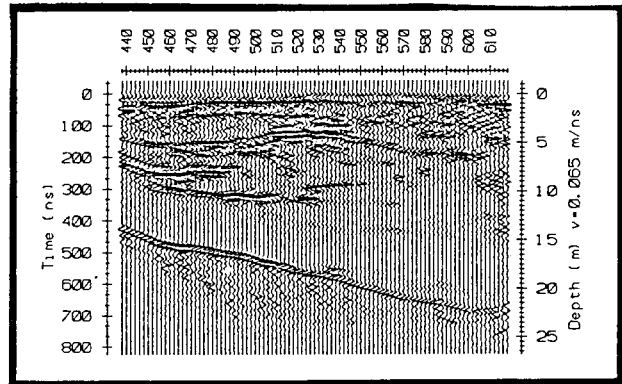

**Ground Radar** is fast, reliable, and proven technology with the ability to work up to 35 metres deep or more.

Applications include:

- **Quick location of Pipelines and Cables with improved certainty over other older methods.**
- **Detect Cavities from surface, no other remote sensing method will do this.**
- **Establish reasons for surface subsidence without expensive excavation.**
- **Non Destructive Road Pavement Surveys - Cover large areas and better understand subgrade and pavement structures without any digging.**
- **Know location of Buried Items, tanks before you excavate, thus improving safety when excavating**
- **Map deep structures, like buried channels, without having to drill holes (saves money and helps better target drillholes before you dig).**
- **Non destructive testing of roads, bridges and other structures. This lets you see pavement structure, rebar position without taking the structure to pieces.**

For a **free** presentation and no obligation discussions on how Ground Radar can serve your needs please call Grant Roberts or Matt Watson at Groundsearch on (9) 826 0700 or fax on (9) 826 0900 or complete and either fax or post the coupon below.

Please arrange to see me in the month of \_\_\_\_\_ for a no obligation **FREE** briefing to show me how this new technology can benefit my business.

Please contact me immediately regarding this new technology

Name..... Company.....  
 Address .....

Phone ..... Fax .....

Groundsearch, Freepost 85446, PO Box 15-038 New Lynn Auckland.  
 Or Fax 9-826-0900 or Email to Radar@groundsearch.co.nz

# BROWN BROS

(N.Z.) LTD.

EST. SINCE 1937

TECHNICALLY  
SUPERIOR

1937



1998

COST  
EFFECTIVE

- FROM - Plain Geotechnical to Deep Off-Shore for Marine Installations
- FROM - Environmental Drilling - to U.S. - E.P.A. Standards.  
Our people are certified in Hazardous Waste Operations
- FROM - City to Village Ground Water Supplies
- FROM - Mine Scout Exploration Drilling to Large De-Watering Wells
- FROM - Reverse Circulation to Bulk Sampling
- FROM - Quarries to Stabilisation
- FROM - Camera Bore Hole Surveys to Directional and Controlled Drilling
- FROM - Simple Seismic to Deep Stratagraphic.

TOP HEAD DRIVE - MULTI PURPOSE - HYDROSTATIC  
DRILLING RIGS - ALL TERRAIN - MOUNTED & HELIPORTABLE  
ENVIRONMENTALLY SENSITIVE EQUIPMENT  
TAKE ADVANTAGE OF OUR 61 CONTINUOUS YEARS  
THE LOGO SAYS IT ALL.

*Try us, we've probably done it, or are about to*

## DRILLING IS "OUR" BUSINESS

CONTRACTORS, ENGINEERS & CONSULTANTS

Telephone 07-849 2919, 09-298 0449, Facsimile 07-849 1729 After Hours 025-471 045

Email [brownbro@voyger.co.nz](mailto:brownbro@voyger.co.nz)

## ***NORTHERN REGION: STUDENT PRIZE ABSTRACTS***

---

### **SUMMARY**

---

#### ***Influence of Weathering and Hydrothermal Alteration on Engineering Characteristics of Eastern Coromandel Rocks***

By: Paul Bassett

#### ***An Engineering Geological Model for Awaroa Opencast Prospect, Huntly***

By: Meagan Stewart

#### ***Engineering Geology of the Kelly Range, Arthur's Pass National Park***

By: Matthew Brown

These papers were all presented for the 1997 Northern Region Student Prize

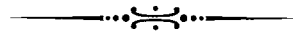

***NZGS is pleased to announce the winner of the Northern Region 1997 Student Prize is:***

***PAUL BASSETT***

for his paper entitled

***Influence of Weathering and Hydrothermal Alteration on Engineering Characteristics of Eastern Coromandel Rocks***

# **INFLUENCE OF WEATHERING AND HYDROTHERMAL ALTERATION ON ENGINEERING CHARACTERISTICS OF EASTERN COROMANDEL ROCKS**

**Paul Bassett**

Department of Earth Sciences, The University of Waikato, PO Box 3105, Hamilton

## **INTRODUCTION**

Along the Kuaotunu Hill Road, Coromandel Peninsula, various grades of weathering can be seen within a geographically small area; this diversity in weathering presents considerable difficulty to designers currently realigning this section of road. These problems are exacerbated by the hydrothermally altered state of many rocks in the region. Pyrite is ubiquitous to hydrothermally altered areas, the acid drainage resulting from its oxidation can pose not only an environmental hazard, but could also seriously affect fill integrity, and road cut stability. This problem could prove to be widespread in hydrothermally altered regions of New Zealand, but presently there is little information available in the literature outside mining applications. Tairua Hill was chosen as a site to study acid drainage.

## **AIMS**

The aims of this study are to:

- 1) gain an understanding of relationships between the strength, mineralogy and geochemistry, of weathered and hydrothermally altered greywackes and andesites; and
- 2) determine if acid drainage has any significance in terms of slope stability.

## **METHODOLOGY**

Engineering geology mapping techniques (NZ Geomechanics Society, 1988) and field geotechnical index tests (including resistance to penetration and Schmidt hammer rebound) were used to classify road cuts at Kuaotunu Hill into various weathering categories, and to delineate the various lithologies present at Tairua Hill. This provided a basis for sampling material for laboratory testing. Geotechnical tests being undertaken on sampled material include Atterberg limits, density, porosity, slake durability, point load, direct shear, ring shear, optimum water content and Californian bearing ratio (CBR). CBR is being undertaken on samples at saturated and optimum water contents. Mineralogical and geochemical investigations include bulk and orientated (for clay mineralogy) x-ray diffraction (XRD), x-ray fluorescence (XRF) (for absolute chemical composition), and optical analysis using a scanning electron microscope. XRF data also allows a weathering index ( $W_z$ ) based on the ratio between

mobile and immobile elements produced by weathering to be calculated (Hodder, 1984). Chemical composition at Tairua Hill is of particular importance as the presence of sulphur indicates the need for further investigation into the acid potential of this material (Byerly, 1996).

## WEATHERING

Field investigations indicate a steady progression of weathering states at Kuaotunu Hill from unweathered (UW) to completely weathered (CW) in both greywacke and andesite. This is characterised by an increase in discontinuities, rock discoloration and clay content, and a decrease in strength. Laboratory test results show a clear reduction in density, strength and durability with increased weathering and a corresponding increase in porosity, moisture content (both field and optimum) and clay content (Table 1).

Table 1: Laboratory test results for Kuaotunu Hill

Unit	$W_z$ Index	CBR (%)	Slake Durability (%)	Porosity (%)	Dry Density ( $\text{kg m}^{-3}$ )
CW Greywacke	0.23	30	54	33.76	1473.87
HW Greywacke	0.24	30	77	29.79	1651.26
MW Greywacke	0.55	45	97	9.30	2329.87
SW Greywacke	0.72	55	99	4.01	2573.01
UW Greywacke	1	NA	100	1.01	2661.72
CW Andesite	0.13	15	15	45.37	1141.39
HW Andesite	0.24	20	65	22.31	1669.25
MW Andesite	0.79	45	78	7.43	2364.64
SW Andesite	0.89	55	98	5.80	2442.90
UW Andesite	1	NA	99	4.57	2496.42

In order to ascertain relationships between weathering and geomechanical properties, correlation coefficients for regressions of  $W_z$  and strength results were obtained. The regression between slake durability and  $W_z$  (Figure 1) is displayed by a log relationship. This is due to the increasing susceptibility of the rocks to wetting and drying as they become more weathered. Figures 2 - 4 show linear relationships between  $W_z$  and dry density, porosity and CBR. It can be observed in Figure 4 that CBR displays an almost perfect relationship (correlation coefficients of 0.99 for both greywacke and andesite) with  $W_z$ .

This raises the possibility of using  $W_z$  as a surrogate for CBR during design. The CBR laboratory test needs upwards of 18 kg of material whereas the weathering index requires only 10 g. Using  $W_z$  as an index for assessing the suitability of sub-base materials for roading holds some obvious advantages in time, versatility and cost. An example of where  $W_z$  would be useful can be seen at Kuaotunu Hill where engineering

geological conditions and road engineering have exacerbated already difficult design conditions by forming very steep road embankments with up to 6 m of fill above country rock. This makes recovery of the necessary volume of country rock for geotechnical testing difficult and samples costly, potentially leaving designers with compromised data to use during planning. On the other hand, obtaining the 10 g necessary for XRF is a much simpler proposition involving auger equipment.

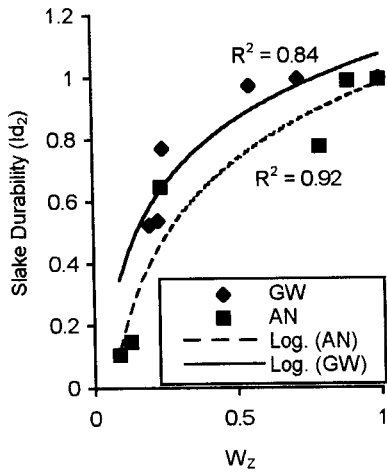

Fig. 1: Relationship between  $W_z$  and Slake Durability

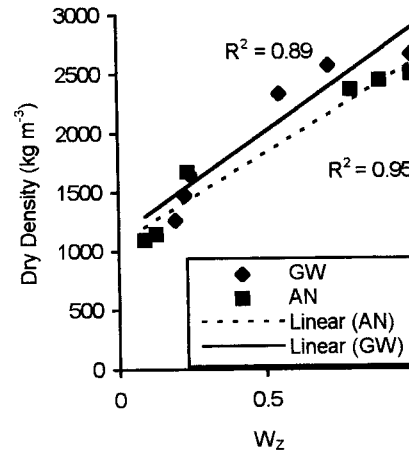

Fig. 2: Relationship between  $W_z$  and Dry Density

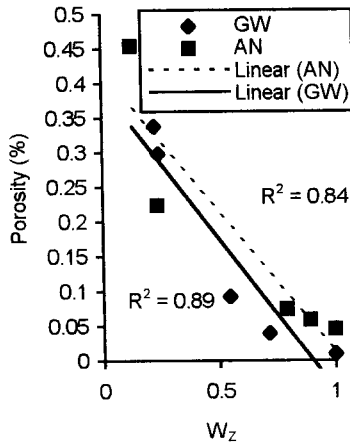

Fig. 3: Relationship between  $W_z$  and Porosity

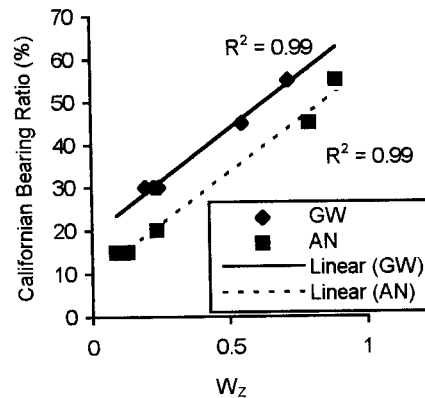

Fig. 4: Relationship between  $W_z$  and CBR

## ACID DRAINAGE

Cut and fill operations at Tairua Hill were undertaken within a sequence of hydrothermally altered andesites and overlying tephra to facilitate the realignment of a

section of State Highway 25 north of Tairua. After the cut was made, a rotational slide occurred and began retrogressing into the slope face. Field investigations have revealed that the material in this cut is affected by past hydrothermal alteration. Clays such as halloysite, smectite and kaolinite dominate the altered material. Many other minerals are introduced during alteration including pyrite, which is the key component of acid drainage. A sheared layer at the base of the cut (Unit TH7, Figure 5) was identified as being the most likely basal failure surface. Concentrations of pyrite were visible in the immediately overlying unit (Unit TH6, Figure 5), which also has many of the same characteristics as the failure material. Unit TH7 contains less visible pyrite and smells strongly of sulphur. This smell is related to the oxidation of pyrite, which also releases sulphuric acid into the surrounding environment (acid drainage).

Table 2: Laboratory test results for Tairua Hill

Unit	Density (kg m <sup>-3</sup> )	Cohesion (kPa)	Friction Angle	PH	Wt. % Sulphur	Net Acid Prod. Pot. (t/1000t CaCO <sub>3</sub> )
TH1	1370	2	27°	6.79	0.02	
TH5	1827	12	32°	4.56	0.03	
TH4	1662	29	17°	4.81	0.04	8.5
TH6	2097	22	16°	3.14	13.0	476
TH7	1542	2	12°	3.08	3.9	150
TH9	1856	13	34°	4.23	0.24	

To test for acid drainage a series of Net Acid Producing Potential (NAPP) tests were undertaken. Two samples (Units TH6 and TH7), were selected for testing based on their very high sulphur contents, with a third sample (Unit TH4) being considered representative of the remaining units (Table 2). Results are given in tonnes of calcium carbonate needed to neutralise the acid potentially produced by every 1000 tonnes of rock. The United States Department of Transportation guidelines for handling acid

producing material (Byerly, 1990) indicate that a NAPP value of greater than 5 t/1000t CaCO<sub>3</sub> requires specialist treatment during construction. It should be noted that at pH values of between 2.8 and 3.2, bacteria (*Thiobacilli ferrooxidans*) begin a reaction which can speed up the oxidation of pyrite by as much as 500 000 times (Byerly, 1996). These bacteria are

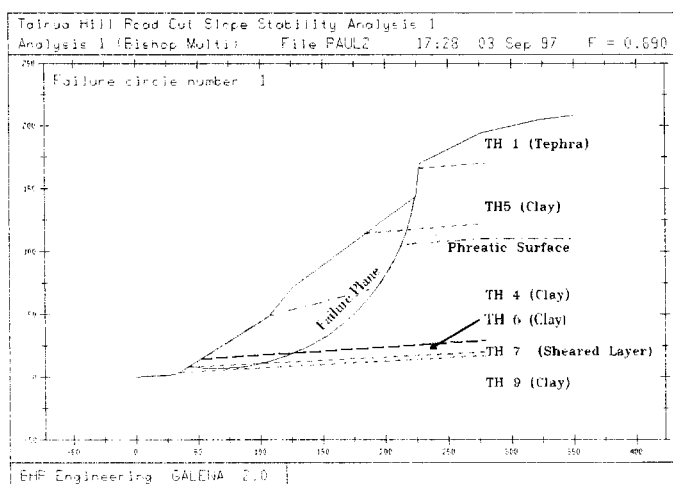

Fig. 5: Tairua Hill slope stability analysis with partial saturation

ubiquitous to all sulphidic environments. These reactions will certainly be taking place in Units TH6 and TH7, and as this lowers the pH of the surrounding rock, these biological reactions will tend to propagate through the host rock.

A stability analysis using Galena indicates that this slope has a Factor of Safety of 1 under dry conditions and 0.7 after partial saturation (Figure 5) and also backs up field evidence that basal sheared material (Unit TH7) is the most likely cause of failure.

An interpretation of this is that Unit TH6 is in the process of oxidising to form Unit TH7. During this process, it has been structurally weakened by chemical weathering involving the production of sulphuric acid to the point where failure has taken place. This indicates that acid drainage is the primary cause of failure at Tairua Hill. Using this material as fill without specific design considerations holds significant risk as the production of acids could affect the future integrity of the fill structure, and may result in unacceptable environmental contamination.

## CONCLUSION

The Coromandel is a place of diverse geology that has resulted in some interesting and challenging engineering geology problems. Weathering and acid drainage are controlled by similar mechanisms and an awareness of both is needed for engineering geology investigations.

All levels of weathering can be seen over small areas and this can have dramatic effects on the range of strengths and resultant engineering behaviour of rocks and soils. An extremely good correlation between strength parameters and a normalised weathering index has been demonstrated in this study which has potential to improve design efficiency.

Acid drainage has also proven to be a major concern in areas of hydrothermal alteration such as the Coromandel Peninsula. This has the potential to destabilise cut slopes, reduce fill integrity and cause environment pollution. Acid drainage is a process where there is little understanding of its consequences outside the mining industry. The cost of road repairs and redesign indicates it is important to understand its significance to design before construction takes place. Testing samples for total sulphur content can provide major design insights simply and cost-effectively as there is a good correlation between this and acid producing potential.



## REFERENCES

- Byerly, D. W., (1990), *Guidelines for Handling Excavated Acid-Producing Materials*, U. S. Department of Transportation, Federal Highway Administration, DOT FHWA-DF-89-001, Washington, DC, 81p.
- Byerly, D. W., (1996), Handling Acid-Producing Material During Construction, *Environmental and Engineering Geoscience*, Vol. II, No. 1, Spring 1996, pp. 49-57
- Hodder, A. P. W., (1984), Thermodynamic Interpretation of Weathering Indices and its Application to Engineering Properties of Rocks, *Engineering Geology*, Vol. 20, pp. 241-251
- New Zealand Geomechanics Society, (1988), *Guidelines for the Field Description of Soils and Rocks in Engineering Use*. New Zealand Geomechanics Society, Institute of Professional Engineers, Wellington

# AN ENGINEERING GEOLOGICAL MODEL FOR AWAROA OPENCAST PROSPECT, HUNTLY, NEW ZEALAND.

Meagan Stewart

Department of Earth Sciences, The University of Waikato, Private Bag 3105, Hamilton.

Awaroa North Opencast is located within the Rotowaro Coalfield, near Huntly, New Zealand. The existing pit has an area of approximately fifteen hectares and is located at the northern end of the three hundred hectare proposed mine site. The mine is currently extracting coal from three main coal seams within the Waikato Coal Measures. Overlying coal seams at this site are Tertiary soft rocks - units of the Te Kuiti Group, commonly referred to as 'papa' and geologically known as Glen Afton Claystone, Pukemiro Sandstone, and Mangakotuku Siltstone. The past, present and possible future behaviour of these materials within the proposed mine site are investigated in this engineering geology model. Data collected and interpretation of the findings will aid planning and design of slope batters and the mine.

Engineering geological mapping aimed at the recognition and location of features relevant to mine stability was carried out using a portable Global Positioning System (GPS). Relevant features include both recent and ancient slope movements and their nature, effect of past underground mining such as subsidence, areas of groundwater seepage and recognition of groundwater levels. Description and mapping of the existing open cast mine was done so that any important or dominant structure could be recognised. With the aid of stereonets, data collected from scanlines at various sites throughout the pit were analysed. A laboratory programme was designed to adequately classify both the 'papa' material and the coal measures. Data collected includes strength - determined using Point Load and Cone Indenter methods, correlated with Uniaxial Compressive Strength tests - as well as slake-durability, particle size, porosity and bulk density.

Field investigations revealed numerous slope failures, reflecting both the inherent slumping nature of the underlying materials and the effects of past mining. Large translational and more complex landslides are common and are often associated with the seepage of groundwater. An example of this is shown in plate one which shows a complex slide above a swampy area. Three large debris flows have been recognised in the area and again seem to be directly related to areas of high water-table, one of which is seen in plate two.

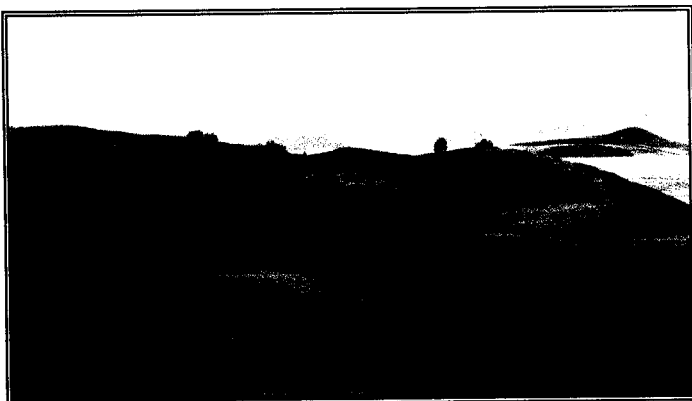

Plate One: Ancient complex landslide, the main or initial failure is a rotational rock slide.



Plate Two: Preserved debris flow, with scarp at top of slope, main track and lobe clearly visible.

Areas of collapse are prevalent over old underground mine workings, and where vertical shafts have caved in small circular scarps or sinkholes have developed. A slope near an old mine entrance is shown in plate three, where shallow sinkholes are clearly evident.

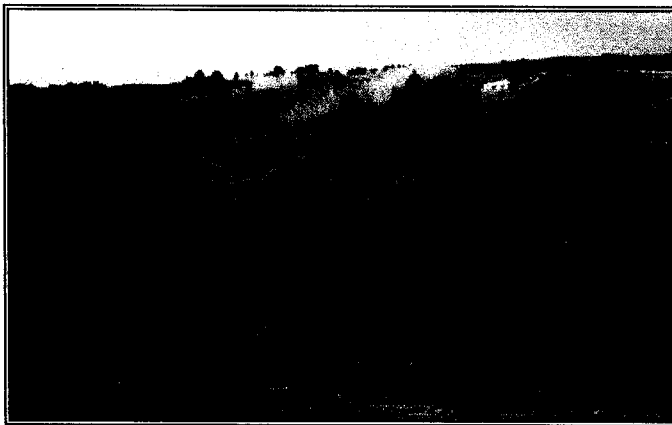

Plate Three: A hillslope above old underground workings, with sinkholes developed over shafts.

Observations from the present mine pit show that large wedge failures are not common, although there are some small wedge failures present. Stereonet analysis has shown that although there are no regional dominant joint sets, there are small localised joint sets present. Five separate units have been determined on the basis of the pit layout, with the following dominant joint sets recognised at each: -

Lower Coal Measures: 081 04; 245 03 (dip direction/dip)

Upper Coal Measures: 331 17; 057 14

Lower 'papa' Unit: 168 31

Middle 'papa' Unit: 086 10

Upper 'papa' Unit: 220 07; 356 65.

Strength tests revealed that the uniaxial compressive strength (UCS) of these 'papa' materials are extremely low, although typical for such soft rocks. The UCS of the upper coal measures show they are slightly stronger, with results shown in table one. Strength of materials was determined using Uniaxial Compressive Strength tests, as well as point load, and cone indenter methods. Because UCS testing is

very time consuming and often impractical, NCB cone indenter and point load can be used as alternative strength tests. However a representative number of rock samples need to be tested using each method so that a relationship between UCS and the other method can be derived.

The cone indenter method provided the best experimental results. This was determined by the close relationship between UCS and Cone Indenter test results as shown in figure one below. This relationship can be used to estimate UCS values for those samples which were tested by only the cone indenter technique, with utmost confidence that the relationship is relevant to the sample set.

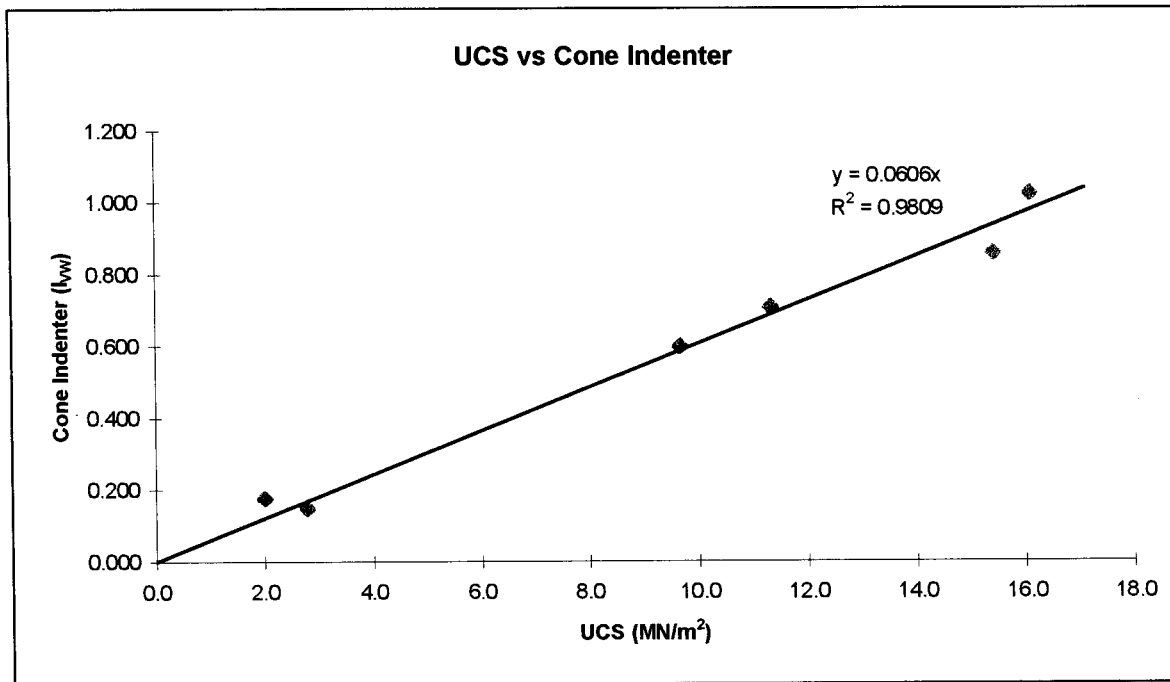

**Figure One:** Relationship between UCS (MN/m<sup>2</sup>) and Cone Indenter numbers (I<sub>s</sub>), for six of the sample sites.

Other laboratory investigations have revealed very little variation between units in their geotechnical properties. Particle size analysis shows all samples are dominated in clay and fine silt, with clay content ranging from 38% to 69%, and fine silt content ranging from 13% to 38%. Other properties are summarised in Table One.

	Bulk Density (kg/m <sup>3</sup> )	Porosity (%)	Strength(UCS) (KN/m <sup>3</sup> )	Slake Durability (2 cycles)
Mudrocks	1570 - 1590	38.4 - 40.3	1.7 - 2.9	0.06 - 1.68
Coal Measures	1500 - 1630	37.0 - 43.0	5.6 - 16.9	81.8 - 86.5

**Table One:** Summary of properties of rocks in the present Awaroa opencast mine.

As the materials have very low strengths, slope movements are inevitable, even with the lack of any controlling structural pattern. The lack of large wedge failures apparent in the field is supported by stereonet analysis which shows there are no regionally dominant joint sets. The small wedge failures present seem to be dominated by stress relief. As expected water is especially relevant to the behaviour of

the 'papa' materials. This is supported by field observations of movement in slopes above seepage zones. It is proposed that slaking is an important factor in the stability of slopes, and preliminary laboratory tests have shown the 'papa' materials have a very low slake-durability index. The above field and laboratory work has been complemented with analysis of data from numerous drillholes at the mine site, along with geophysical logs from a selected number of the boreholes. These data are used to recognise underlying geology and geological properties of material which is not yet exposed. This information can be combined with both field observations and laboratory work to produce an overall three dimensional model of the existing and proposed mine site. With the use of *Vulcan*, a mine planning multi-level computer programme, this can be presented in both a tabulated and graphical form. With knowledge accrued from this study and elsewhere, the local structural geological controls on the materials encountered during mining can be determined.

Acknowledgment: Support for this project is being provided by Solid Energy North.

## New Zealand Geotechnical Society

### Abstract

## Engineering geology of the Kelly Range, Arthur's Pass National Park, South Island, New Zealand

Matthew Brown (Auckland University, Geology Dept, Msc Thesis student)

The Kelly Range is located on the north western boundary of the Arthur's Pass National Park, South Island. This north east striking range has not been previously studied in detail. A focus of this study is to test Beck's (1968) theory of topographic readjustment of the Southern Alps. Beck modelled large ridge rents on the Kelly Range and related them to his theory of gravitational collapse in the Southern Alps. Beck's model has important implications as his model has been incorporated into slope movement classifications in some geotechnical literature. It is an aim of my thesis to elucidate further the slope processes forming these structures and to produce my own model to explain ridge rent development on the Kelly Range.

Methods of obtaining data includes both geological and geomorphological mapping, structural geology, rock defect analysis and slope processes. From the field data cross sections can be constructed to model ridge rent (uphill facing scarp) development on Kelly Range, which could be relevant to the Southern Alps.

### Rock Types

Kelly Range consists of weakly metamorphosed rocks of interbedded, uw-sw, strong sandstones (R4) and uw-sw weak mudstones/argillite (R3). These field strength classifications are field estimates with the sandstones having similar mechanical properties to the basement greywacke rocks.

Another major rock unit is a broken formation, a chaotic mixture of sandstone and argillite. This unit would have similar mechanical properties to the argillite units. All these rock units are highly fractured with cleavage and bedding providing the most dominate defect sets. These defect orientations are an important inclusion in the slope movement processes taking place on Kelly Range. Defect orientations predispose the slopes to fail by either toppling, wedging, sliding and ridge rents. In one location all failure modes are evident in an active 1km long erosional gully which provides excellent defect data.

### Ridge rents, uphill facing scarps or sackung

Ridge rents, or uphill facing scarps, are curve linear topographic features which are widespread throughout the Southern Alps. These structures are found in fractured greywacke and schists in New Zealand.

They are a world wide recognised feature and have been described in detail from high alpine areas such as Scotland, Canada, U.S.A, Europe, Japan as well as the Southern Alps of New Zealand.

Unfortunately the mechanics into the formation of ridge rents is poorly understood. Previous models of ridge rent development have included rock mass creep or gravitational deformation, toppling, gravity faulting and suckung (sagging). But a common feature of ridge rents is that they are site specific structures which are controlled by the local structure and rock type.

### Toppling / wedge theory

The model proposed for this study into the development of uphill facing scarps, on Kelly Range, is that of a toppling and wedging failure rather than topographic readjustment modelled by A. C. Beck in 1968.

Any rock mass beneath a slope can deform continuously with or without the development of a sliding surface, when subjected to a unstable gravitational state for a long period of time. Observations and data from the study area show that conditions prevail for toppling failure to occur, eg preferred defect orientations, oversteepened slopes (due to glacial erosion and high uplift rates for this part of the Southern Alps), rock types and topographic location.

To what depth the penetrative defects continue, below the surface is of interest. With the assistance of a 30m mining tunnel on Kelly Range, major defect penetrate to a depth of at least 15m, but these could continue to a depth of 10's of meters below the surface. This depth is an important factor in ridge rent development.

Other evidence for the development of ridge rents on Kelly Range include, deglaciation (removing lateral support of the slopes), favourable defect orientations, seismic shock, gravity, development on pre disposed planes of weakness (ie fault gouge zones) and oversteepened slopes.

### Cross section B-B', Kelly Range

Wedging and toppling of ridge rents

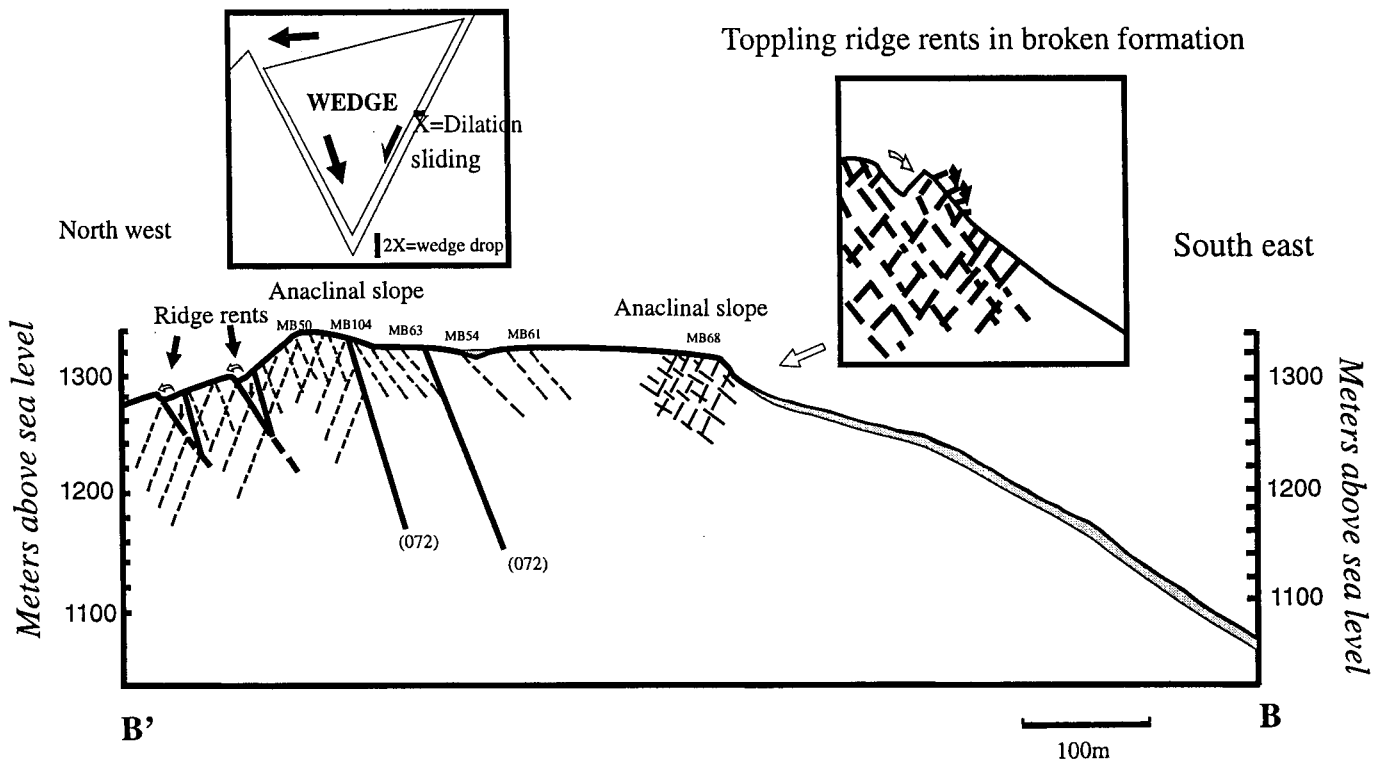

*Fig 1 Cross section model used to explain the toppling wedging theory of ridge rent formation on Kelly Range.*

### **Engineering geological hazards**

Ridge rents, on Kelly Range, can reach up to 800-1000m in length and have scarps which are 15-20m in height. These structures have potential to fail as large landslides, with the failure plane some 10's of meters below the surface. This catastrophic slope failure would produce large rock avalanches of disaggregated material which have the ability to travel at a high velocity, and some distance from the failure site.

The triggering effect would be a large earthquake or by the natural gravitational effect of the uphill facing scarps. As well as been a hazard for structures on Kelly Range and areas down slope, similar ridge rent structures are seen in other areas of the Arthur's Pass National Park eg Temple Basin ski area and the head scarp area of the zig zag, State Highway 73. With the proximity of active faulting in the Arthur's Pass region, seismic activity should be a paramount factor in assessing hazards in the area with the recognition of ridge rents as a potential large rock avalanche hazard.

An important factor in the origins of ridge rents is to determine whether they are tectonic or a purely a slope process. On Kelly Range there is evidence to show that ridge rents have formed on the planes of weakness such as faults. This factor could lead to different conclusions to rock quality, the stability of the rock mass and the foundation requirements at depth.

This is significant in site investigations, as well as hazard assessment, with structures in alpine areas, such as ski facilities, T.V and radio relay stations, tramping and alpine huts, power lines and other utilities.

### **References**

Beck, A. C., 1968. Gravity faulting as a mechanism of topographic adjustment. *New Zealand Journal of Geology and Geophysics* 11: 191-199.



## Call for Papers

The Convenors invite interested parties to submit an abstract for consideration to be included in the programme. All accepted papers will be published in the Symposium Proceedings which will be available to attendees upon arrival at the Symposium.

## Key Dates

Submission of Abstracts: 30 January 1998  
Confirmation of Acceptance: 13 February 1998  
Submission of Full Paper: 30 April 1998

Abstracts should be 100-200 words with a clear title and 1 sentence statement of key words/subject content at the start.

Abstracts should be submitted to Barry Williams, Centre for Continuing Education, University of Auckland. See contact details below. If sending by coded email please send as an Attachment, not in the body of the message.

## Symposium Convenors

Geoffrey Farquhar, Worley Consultants Ltd  
Stephen Crawford, Tonkin & Taylor Ltd  
Kelvin Moody, Opus International Consultants Ltd

## Administration

All inquiries and submission of abstracts to:

Mr Barry Williams  
Centre for Continuing Education,  
The University of Auckland  
Private Bag 92019, AUCKLAND  
Telephone: (09) 373 7599 (extn 8903)  
Fax: (09) 373 7419  
Email: b.williams@auckland.ac.nz

Symposium website:  
<http://www.cce.auckland.ac.nz/geotech>

## NEW ZEALAND GEOTECHNICAL SOCIETY SYMPOSIUM



# Roading Geotechnics '98

July 3-5 1998

at The Conference Centre  
The University of Auckland

1st Announcement  
Call for Papers

 IpeNz Endorsed

**1999****FEBRUARY, 1999**

Hobart, Australia  
8<sup>TH</sup> ANZ CONFERENCE

**JUNE 7-10, 1999**

Amsterdam The Netherlands  
XIIth European Conference on Soil Mechanics  
and Foundation Engineering.  
"Geotechnical Engineering for Transportation  
Infrastructure"

**JUNE 21-25, 1999**

Lisboa, Portugal  
Second International Conference on Earthquake  
Geotechnical Engineering.  
Topics:

- Dynamic Characterisation of Soils
- Strong Motions
- Soil Structure Interaction
- Seismic Behaviour of Buried Structures
- Liquefaction
- Seismic Behaviour of Slopes and Embankments
- Seismic Design Criteria and Safety Evaluation
- Lessons Learned from Recent Earthquakes

**AUGUST 8-12, 1999**

Foz do Iguaca, Brazil  
XI Panamerican Conference on Soil Mechanics  
and Geotechnical Engineering.

**AUGUST 23-27, 1999**

Seoul, Korea  
11<sup>TH</sup> ASIAN REGIONAL CONFERENCE  
Themes:

- Engineering properties of soils and rocks
- Deep and shallow foundations
- Underground excavation and tunnelling
- Earth structures and slopes
- Natural hazards and ground Improvements
- Environmental geotechnique
- Soil dynamics and earthquake engineering
- Case histories in Geotechnical engineering

**AUGUST 25-28, 1999**

Paris, France  
9<sup>th</sup> International Congress on Rock Mechanics:  

- Applied rock mechanics, safety and environment
- Coupling between mechanical, thermal, hydraulic
- Rock dynamics and Tectonophysics
- Monitoring, in situ tests and field measurements

**2000****JUNE 26-30, 1998**

Cardiff, UK  
8<sup>TH</sup> IS ON LANDSLIDES  
BRITISH GEOTECHNICAL SOCIETY

**OCTOBER 23-27**

Melbourne, Australia  
GEO ENG 2000. INTERNATIONAL CONGRESS  
SPONSORED JOINTLY BY ISSMFE, IAEG AND  
ISRM

**Footnote:** For further details on contacts or brochures for any of the above conferences or symposia please contact the Editor of NZ Geotechnical News.

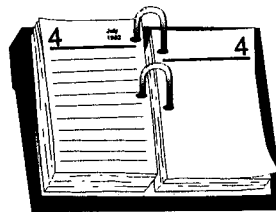

The following publications of the Society are available from the Secretary, IPENZ, P.O. Box 12241, Wellington North. Some publications have been reduced in price to members to clear excess stocks. All prices exclude postage and GST.

	LIST PRICE	
	MEMBERS	NON MEMBERS
Proceedings of the 7 <sup>th</sup> Australia-New Zealand Conference on Geomechanics, Adelaide, July 1996	Aus\$160.00 approx.	
Proceedings of the Second Australia-New Zealand Young Geotechnical Professionals Conferences, Auckland, December 1995	\$ 25.00	\$ 40.00
<b>Australia-NZ Conferences on Geomechanics</b> Proceedings of the Sixth Australia-NZ Conference on Geomechanics, Christchurch, February 1992	\$50.00	\$100.00
Proceedings of the Third Australia-NZ Conference on Geomechanics, Wellington, May 1980	\$ 10.00	\$ 30.00
<b>NZ Geomechanics Society Symposiums</b> Geotechnical Issues in Land Development. Proceedings of Technical Groups. Vol.22, Issue 1G, Hamilton, 1996	\$ 20.00	\$ 35.00
Proceedings of the Auckland Symposium "Groundwater and Seepage", May 1990	\$ 10.00	\$ 45.00
Proceedings of the Alexandra Symposium "Engineering for Dams and Canals", November 1983 (a joint Symposia with NZSOLD)	\$ 10.00	\$ 50.00
<b>Other Publications</b> Guidelines for the Field Description of Soils and Rocks in Engineering Use	\$ 10.00	\$ 13.00
"Stability of House Sites and Foundations - Advice to Prospective House and Section Owners"	\$ 1.00	\$ 1.00
Back dated issues of Geomechanics News	\$ 0.50	\$ 0.50

**OBJECTS**

- (a) To advance the study and application of soil mechanics, rock mechanics and engineering geology among engineers and scientists.
- (b) To advance the practice and application of these disciplines in engineering.
- (c) To implement the statutes of the respective international societies in so far as they are applicable in New Zealand.

**MEMBERSHIP**

Engineers, scientists, technicians, contractors, students and others who are interested in the practice and application of soil mechanics, rock mechanics and engineering geology.

Members are required to affiliate to at least one of the International Societies.  
 Studies are encouraged to affiliate to at least one of the International Societies.

**ANNUAL SUBSCRIPTION**

Annual subscriptions, which include the newsletter are (for 1998)

<i>Members</i>	<i>(IPENZ members)</i>	<i>\$35.00</i>
	<i>(others)</i>	<i>\$50.00</i>
<i>Students</i>	<i>(IPENZ members)</i>	<i>\$17.50</i>
	<i>(others)</i>	<i>\$25.00</i>

Affiliation fees for International Societies are in addition to the basic membership fee:

<i>International Society for Soil Mechanics and Foundation Engineering (ISSMFE)</i>	<i>\$20.00</i>
<i>International Society for Rock Mechanics (ISRM)</i>	<i>\$20.00</i>
<i>International Association of Engineering Geology (IAEG)</i>	<i>\$15.00</i>
<i>(with bulletin)</i>	<i>\$42.50</i>

All correspondence should be addressed to the Secretary. The postal address is:

*NZ Geotechnical Society  
 P O Box 12 241  
 WELLINGTON*

**NZ Geotechnical Society  
 The Institution of Professional Engineers New Zealand (Inc)  
 P.O.Box 12-241  
 WELLINGTON**

**NEW ZEALAND GEOTECHNICAL SOCIETY  
 APPLICATION FOR MEMBERSHIP**

(A Technical Group of the Institution of Professional Engineers New Zealand (Inc))

FULL NAME (Underline Family Name): .....

POSTAL ADDRESS: .....

Phone No.: ..... Fax No.: ..... E-MAIL: .....

ACADEMIC QUALIFICATIONS: .....

PROFESSIONAL MEMBERSHIPS: ..... Year Elected. ....

PRESENT EMPLOYER: .....

OCCUPATION: .....

EXPERIENCE IN GEOMECHANICS: .....

STUDENT MEMBERS:

TERTIARY INSTITUTION: ..... SUPERVISOR: .....

SUPERVISORS SIGNATURE: .....

(Note that the Society's Rules require that in the case of student members "the application must also be countersigned by the student's Supervisor of Studies who thereby certifies that the applicant is indeed a bona-fide full time student of that Tertiary Institution". . . ; **Applications will not be considered without this information**).

**Affiliation to International Societies:** (All full members are required to be affiliated to at least one society, and student members are encouraged to affiliate to at least one Society. Applicants are to indicate below the Society/ies to which they wish to affiliate).

I wish to affiliate to:

<b>International Society for Soil Mechanics and Foundation Engineering</b>	(ISSMFE)	Yes/No
<b>International Society for Rock Mechanics</b>	(ISRM)	Yes/No
<b>International Association of Engineering Geology (IAEG)</b>		Yes/No
<b>(with Bulletin)</b>		Yes/No

**DECLARATION:** If admitted to membership, I agree to abide by the rules of the New Zealand Geotechnical Society

Signed ..... Date...../...../.....

**ANNUAL BASIC SUBSCRIPTION:** Due on notification of acceptance for membership, thereafter on 1st of October. Please do not send subscriptions with this application form. You will be invoiced on acceptance into the Society

**PRIVACY CONDITIONS:** Under the provisions of the Privacy Act 1993, an applicant's authorisation is required for use of their personal information for Society administrative purposes and membership lists. I agree to the above use of this information:

Signed .....Date...../...../.....

(for office use only)

Received by the Society .....  
 Recommended by the Management Committee of the Society .....  
 Approved by the Council of the Institution .....

*NZ Geomechanics News* is published at least twice a year and distributed to the Society's 400 members throughout New Zealand.

This magazine is issued to society members who comprise professional geotechnical and civil engineers and engineering geologists from a wide range of consulting, contracting and university organisations as well as those involved in laboratory and instrumentation services.

Advertisement Location	Single Issue
Back Cover	\$250 <sup>*2</sup>
Inside Cover (Front or Back)	\$200 <sup>*2</sup>
Full Page Internal	\$180
Half Page Internal	\$125
*Note: 1 All rates are excluding GST 2 Subject to availability	

The deadline for advertising copy for the next issue is 8 May 1998. Arranging artwork for your adverts can be carried out at a reasonable additional cost if requested. However, advance notice is required for this additional service.

If you are interested in advertising in the next issue of *NZ Geomechanics News* please contact:

The Publications Officer  
 Alexei Murashev  
 c/o Beca Carter Hollings & Ferner Ltd  
 P.O. Box 3942  
 WELLINGTON

Tel: (04) 473 7551  
 Fax: (04) 473 7911  
 E-mail: amurashev@beca.co.nz

The Editor  
 James Burr  
 C/o Beca Carter Hollings & Ferner  
 P.O. Box 6345  
 AUCKLAND

Tel: (09) 300 9181  
 Fax: (09) 300 9300  
 E-mail: jburr@beca.co.nz

## GEOTECHNICAL INSTRUMENTATION

- Pneumatic Piezometers
- Hydraulic Piezometers
- Inclinometer Tubing & Accessories
- Data Loggers & Readouts
- Vibrating Wire Piezometers
- Load Cells
- Hydrostatic Profile Gauges

*Agents for:* **Slope Indicator (USA)**  
**Soil Instruments (UK)**  
**Geosystems (Aust.)**  
**QED - Groundwater Specialists (USA)**  
**BAT - Groundwater Systems**  
**Enviroequip (Aust.)**  
**RST Instruments (Canada)**

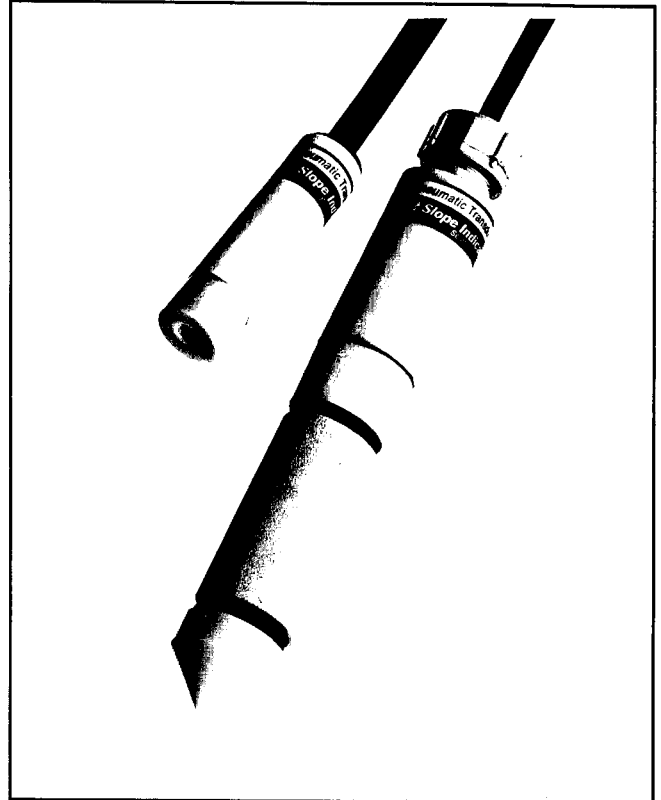

Pneumatic Piezometers

## MONITORING/SAMPLING EQUIPMENT

- Borehole Screen (slotted PVC & access)
- Water Level Meters
- Filter Sock
- Borehole Upstands - lockable
- Disposable Bailers
- Waterra Pumps and Access
- Walton Park sand and gravel
- pH, Temp and Conductivity Meters
- Toby Boxes
- Soil Probes
- NOMIS Seismograph (standard or mini version)



Water Level Meter



**GEOTECHNICS LTD — SALES DIVISION**

UNIT 3C 76 CARR ROAD MT ROSKILL AUCKLAND

PO BOX 27 053 MT ROSKILL AUCKLAND

PH 09 620 0280 TOLL FREE 0508 223 444 FAX 09 620 0281

# SUPERIOR REINFORCEMENT SYSTEMS

For over 20 years we have provided a specialist technical service and a wide variety of superior products to ensure ground stabilisation.

## WALLS/SLOPES

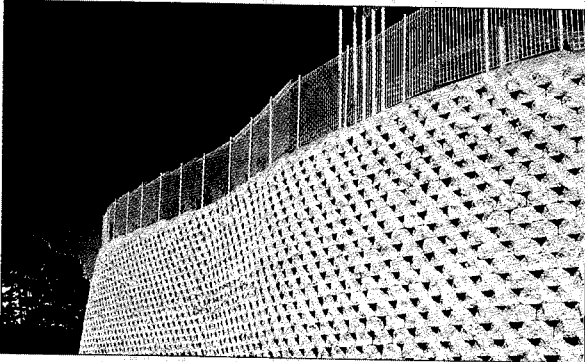

When the need is to hold the ground, we have a range of products for every situation from large scale hillside reinforcement to decorative retaining walls.

## DRAINAGE

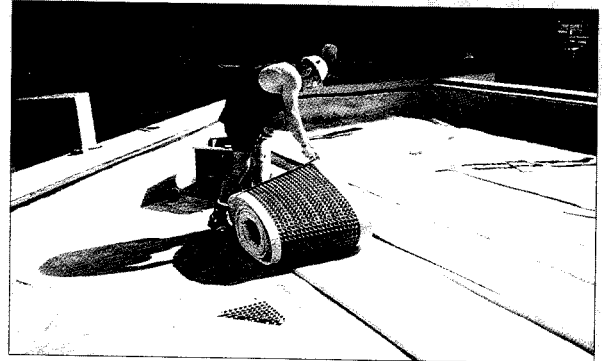

We specialise in a broad range of sophisticated drainage products which are economical and easy to install. The emphasis of these products is to be user friendly with features such as minimum excavation and backfill requirements in addition to high flow rates.

## EROSION CONTROL



We have numerous products to achieve ground holding and erosion control - from biodegradable protection blankets and permanent grass reinforcement systems, to the rugged, heavy duty gabions.

## ROADING

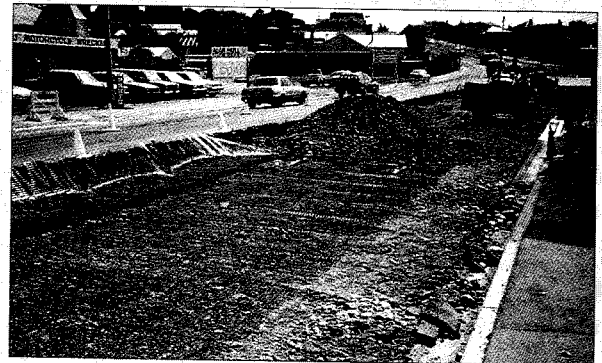

Our roading products are at the forefront of geosynthetic technology. These technically proven products are designed to extend the life of the road and increase the load bearing capacity.

A New Zealand Company.

# GROUND ENGINEERING

**Superior Reinforcement Systems**

AUCKLAND  
PH: 09 579 8215  
FAX: 09 579 4698

CHRISTCHURCH  
PH: 03 349 2268  
FAX: 03 349 3031

Please supply further information on the benefits of Ground Engineering's Superior Reinforcement Systems

Name: \_\_\_\_\_

Address: \_\_\_\_\_

Phone: \_\_\_\_\_

Post coupon to:  
**GROUND ENGINEERING LTD**  
FREEPOST 1439  
AUCKLAND  
FREEPHONE: 0800 659 000

GES